

CITY of NOVI CITY COUNCIL



Agenda Item 3 March 18, 2019

SUBJECT: Approval of the request of Squeaky Shine LLC, JZ18-50, for Zoning Map Amendment 18.727 to rezone property in Section 35, located on the east side of Novi Road between Eight Mile Road and Nine Mile Road, from the I-1, Light Industrial District to the B-3, General Business District. The subject area to be rezoned is approximately 0.68 acres. **FIRST READING**

SUBMITTING DEPARTMENT: Community Development Department - Planning ^{Burb}

CITY MANAGER APPROVAL: 

BACKGROUND INFORMATION:

The petitioner is requesting the rezoning of the southwestern portion of one parcel on the east side of Novi Road north of Eight Mile Road. The subject property is currently zoned I-1, Light Industrial District. The applicant has requested a rezoning to B-3, General Business District. The applicant has indicated the rezoning is requested in order expand their current car wash facility at 21510 Novi Road (already zoned B-3, General Business) to accommodate additional vehicle stacking, parking spaces and vacuum stations.

Staff discussed the Planned Rezoning Overlay option with the applicant, but the applicant has elected to proceed with a standard rezoning. Please note, "auto wash" is considered a Principal Permitted Use in the B-3 district, and if the rezoning is approved by the City Council, a site plan will be considered for approval by the Planning Commission.

The parcels proposed to be rezoned are designated as Industrial Research Development Technology on the Future Land Use Map. The rezoning is not consistent with the Future Land Use Map and the application was brought to the Master Plan and Zoning Committee on January 23, 2019 for discussion. The committee provided some comments regarding the rezoning and submitted concept plan. The Planning Commission then held a public hearing on February 27, 2019 and recommended approval of the application to City Council.

The Planning Review noted that the requested B-3, General Business Zoning District is a reasonable alternative to the recommended land use and will be consistent with the existing zoning to the west. The subject area of property has not been utilized by the owner of the automotive service business and is an L-shaped portion that does not have its own access to Novi Road. Combining the parcel with the adjacent parcel to the west, the car wash facility, will allow greater vehicle stacking space and reduce the potential for traffic to extend onto Novi Road. There are no residential districts immediately adjacent to the subject parcel, as it is separated from the nearest neighborhood by the train tracks and a stormwater pond that will remain I-1 District. At the time of Preliminary Site Plan Review, the Planning Commission should review the Preliminary Site Plan to insure that

there will be no negative impacts (such as additional noise, lighting) on adjacent commercial properties, or the residential property on the east side of the railroad tracks.

The Engineering review indicates there will be no negative impact on public utilities as a result of the proposed rezoning. The City's traffic consultant provided a review letter of the applicant's Rezoning Traffic Impact Study (RTIS). Traffic impacts are not expected to be higher under the proposed B-3 zoning, since it was determined that a similar sized medical office building could be built on the parcel under either the proposed B-3, General Business or the existing I-1, Light Industrial district. Further review of the trip generation counts for the car wash use will be undertaken at the time of Preliminary Site Plan consideration as the information in the ITE Trip Generation Manual, 10th edition, used in the RTIS did not provide enough data to fully determine impacts.

The City's woodland and wetland consultant has confirmed there are no regulated woodlands or wetlands on site, although the 25-foot wetland buffer may be impacted by development. Impacts to natural features, if any, will be reviewed and discussed during future site plan submittal for any project on the property, with required mitigation as determined at that time.

Staff **recommends approval** of the proposed Zoning Map Amendment, which would rezone the property from I-1, Light Industrial District to the B-3, General Business District. The Planning Commission held the required public hearing on this matter on February 27, 2019 and **recommended favorable consideration** of the request, for the reasons provided in the attached draft meeting minutes.

RECOMMENDED ACTION: Approval of the request of Squeaky Shine LLC, JZ18-50, for Zoning Map Amendment 18.727 to rezone property in Section 35, located on the east side of Novi Road between Eight Mile Road and Nine Mile Road, from the I-1, Light Industrial District to the B-3, General Business District, **FIRST READING**, for the following reasons:

1. The Master Plan for Land Use objective to foster a favorable business climate is fulfilled by allowing an existing business to expand,
2. The Master Plan for Land Use objective to support and strengthen existing businesses is fulfilled by allowing an existing business to expand and develop a vacant parcel,
3. This is a reasonable alternative to the recommended land use and will be consistent with zoning to the west,
4. Noise data supplied by the applicant that the proposed use will not cause impacts above the threshold level in the Zoning Ordinance,
5. There is no negative impact expected on public utilities as stated in the Engineering memo,
6. The Rezoning Traffic Impact Statement has demonstrated that the proposed rezoning will not degrade the level of service of the local road network below acceptable levels, and
7. The rezoning provides an opportunity for a long-standing business to expand at their current location, with the submittal of a site plan anticipated once the rezoning is approved.

MAPS
Location
Zoning
Future Land Use
Natural Features

SQUEAKY SHINE CAR WASH: JZ 18-50

LOCATION

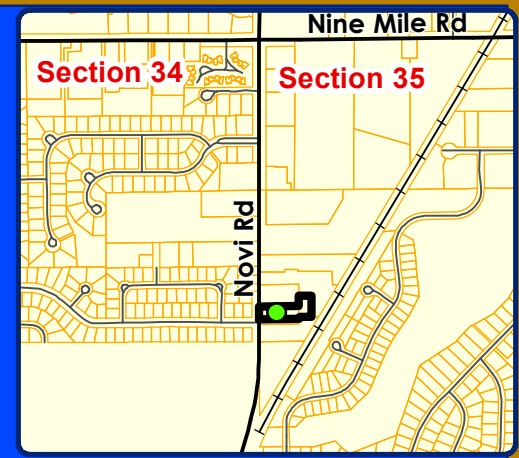

LEGEND

 Subject Property

**City of Novi**
Dept. of Community Development
City Hall / Civic Center
45175 W Ten Mile Rd
Novi, MI 48375
cityofnovi.org

Map Author: Lindsay Bell
Date: 1/10/19
Project: Squeaky Shine JZ18-50
Version #: 1

0 40 80 160 240 Feet
1 inch = 184 feet



MAP INTERPRETATION NOTICE

Map information depicted is not intended to replace or substitute for any official or primary source. This map was intended to meet National Map Accuracy Standards and use the most recent, accurate sources available to the people of the City of Novi. Boundary measurements and area calculations are approximate and should not be construed as survey measurements performed by a licensed Michigan Surveyor as defined in Michigan Public Act 132 of 1970 as amended. Please contact the City GIS Manager to confirm source and accuracy information related to this map.

SQUEAKY SHINE CAR WASH: JZ 18-50

ZONING

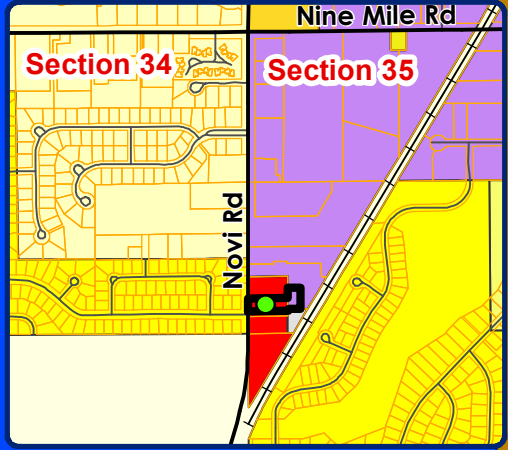
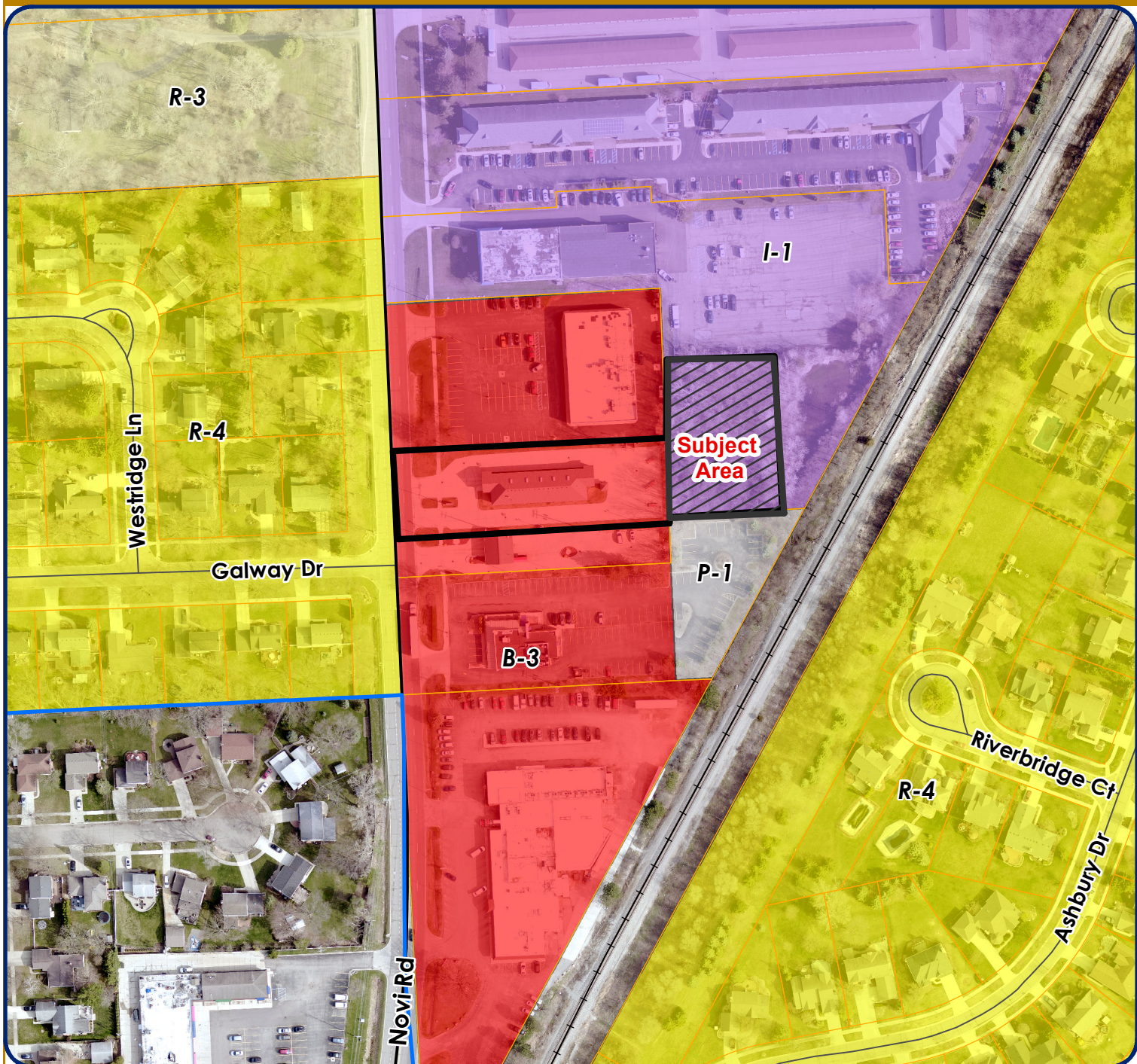

- LEGEND**
- R-1: One-Family Residential District
 - R-2: One-Family Residential
 - R-3: One-Family Residential District
 - R-4: One-Family Residential District
 - RM-1: Low-Density Multiple Family
 - B-3: General Business District
 - I-1: Light Industrial District
 - P-1: Vehicular Parking District
 - Subject Property



City of Novi
 Dept. of Community Development
 City Hall / Civic Center
 45175 W Ten Mile Rd
 Novi, MI 48375
cityofnovi.org

Map Author: Lindsay Bell
 Date: 1/10/19
 Project: Squeaky Shine JZ18-50
 Version #: 1

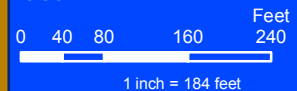

MAP INTERPRETATION NOTICE
 Map information depicted is not intended to replace or substitute for any official or primary source. This map was intended to meet National Map Accuracy Standards and use the most recent, accurate sources available to the people of the City of Novi. Boundary measurements and area calculations are approximate and should not be construed as survey measurements performed by a licensed Michigan Surveyor as defined in Michigan Public Act 132 of 1970 as amended. Please contact the City GIS Manager to confirm source and accuracy information related to this map.

SQUEAKY SHINE CAR WASH: JZ 18-50

FUTURE LAND USE

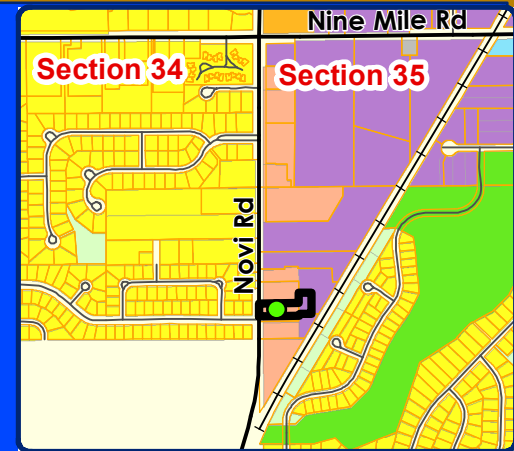
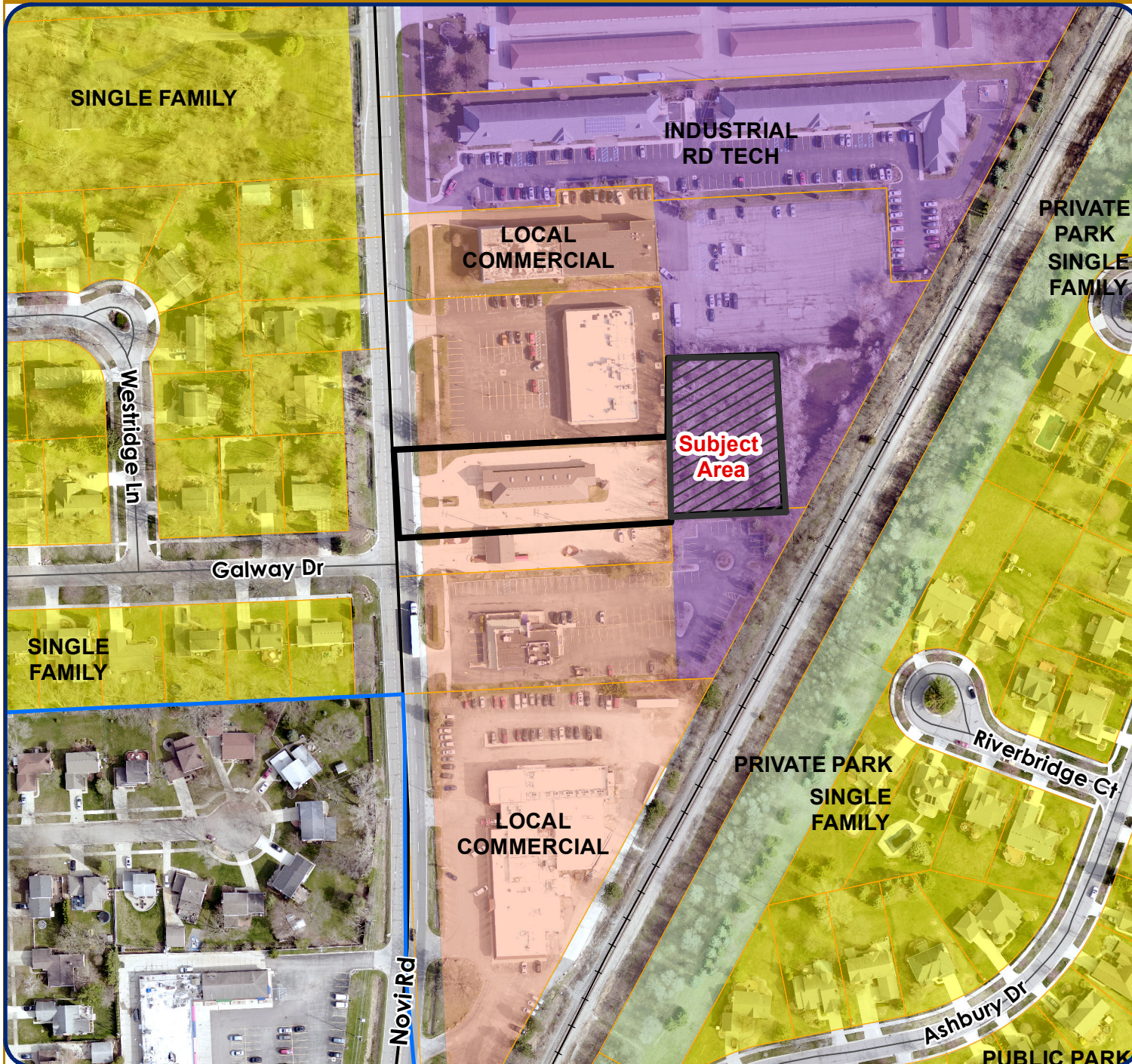

LEGEND

- Single Family
- Multiple Family
- Industrial Research Development Technology
- Local Commercial
- Public
- Public Park
- Private Park
- Cemetery
- Subject Property



City of Novi

Dept. of Community Development
 City Hall / Civic Center
 45175 W Ten Mile Rd
 Novi, MI 48375
cityofnovi.org

Map Author: Lindsay Bell
 Date: 1/10/19
 Project: Squeaky Shine JZ18-50
 Version #: 1

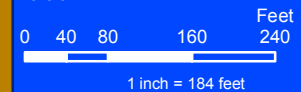

MAP INTERPRETATION NOTICE

Map information depicted is not intended to replace or substitute for any official or primary source. This map was intended to meet National Map Accuracy Standards and use the most recent, accurate sources available to the people of the City of Novi. Boundary measurements and area calculations are approximate and should not be construed as survey measurements performed by a licensed Michigan Surveyor as defined in Michigan Public Act 132 of 1970 as amended. Please contact the City GIS Manager to confirm source and accuracy information related to this map.

SQUEAKY SHINE CAR WASH: JZ 18-50

NATURAL FEATURES

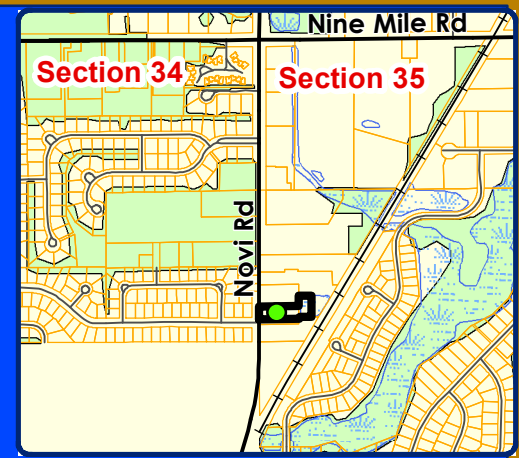

- LEGEND**
- WETLANDS
 - WOODLANDS
 - Subject Property



City of Novi
Dept. of Community Development
City Hall / Civic Center
45175 W Ten Mile Rd
Novi, MI 48375
cityofnovi.org

Map Author: Lindsay Bell
Date: 1/10/19
Project: Squeaky Shine JZ18-50
Version #: 1

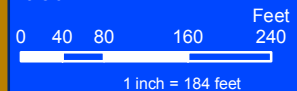

MAP INTERPRETATION NOTICE

Map information depicted is not intended to replace or substitute for any official or primary source. This map was intended to meet National Map Accuracy Standards and use the most recent, accurate sources available to the people of the City of Novi. Boundary measurements and area calculations are approximate and should not be construed as survey measurements performed by a licensed Michigan Surveyor as defined in Michigan Public Act 132 of 1970 as amended. Please contact the City GIS Manager to confirm source and accuracy information related to this map.

REZONING REQUEST

Squiraky Shine Car Wash (fka Wash Me) JZ18-50 Rezoning

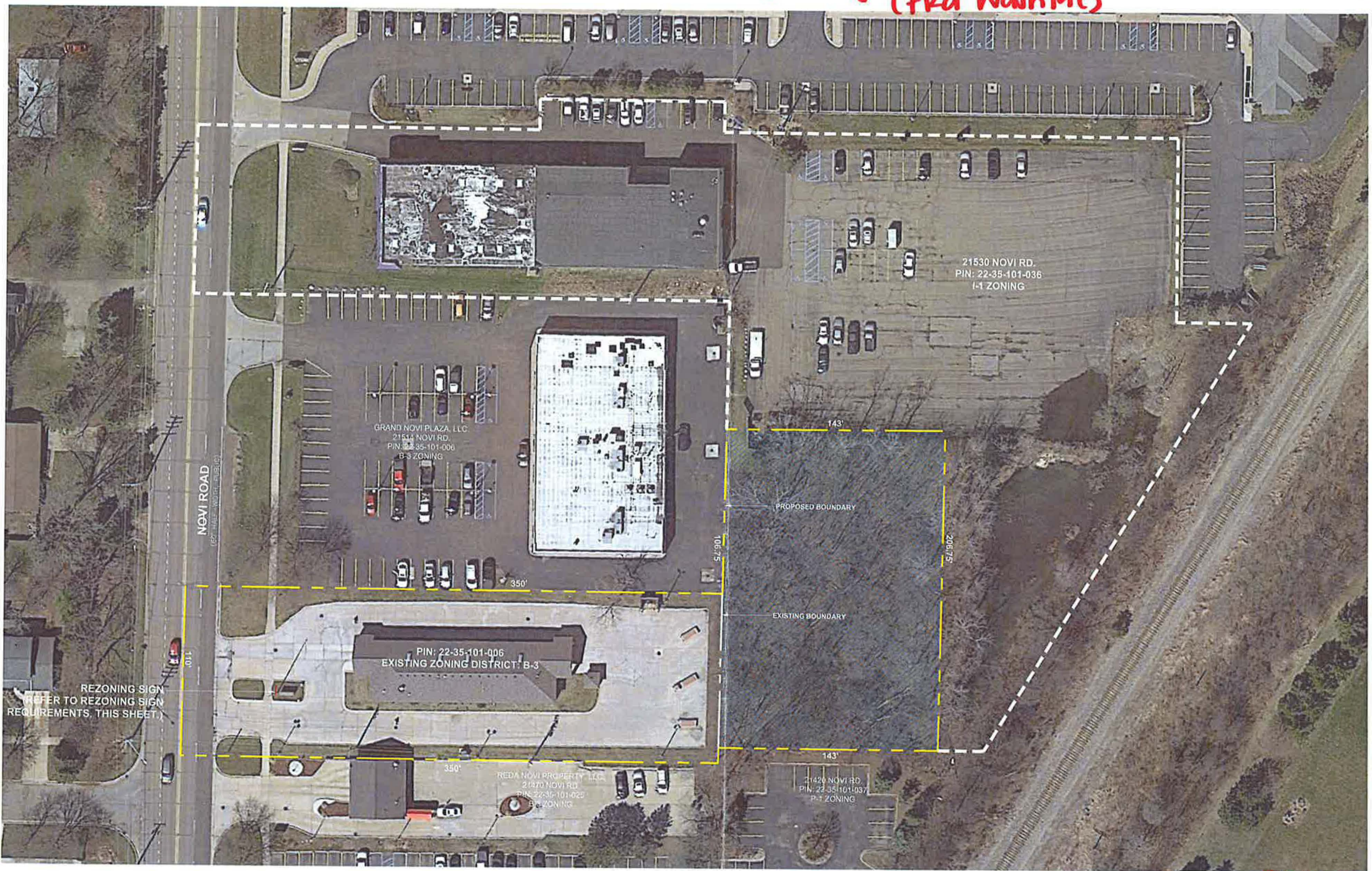

REZONING SIGN REFER TO REZONING SIGN REQUIREMENTS, THIS SHEET.

- REZONING SIGN REQUIREMENTS**
1. BLACK LETTERS ON WHITE BACKGROUND.
 2. SIZE: MIN. FOUR FEET (VERTICAL) BY SIX FEET (HORIZONTAL).
 3. SIGN FACE MUST BE EXTERIOR PLYWOOD, ALUMINUM OR A SIMILAR DURABLE ALL-WEATHER MATERIAL.
 4. SIGN SUPPORT SYSTEM MUST BE STRUCTURALLY SOUND AND ABLE TO WITHSTAND LATERAL WIND OF FOURTEEN POUNDS PER SQUARE FOOT.
 5. SEE DETAIL, THIS SHEET FOR SPECIFIC WORDING.
 6. REZONING SIGNS MUST BE REMOVED WITHIN:
 - SEVEN DAYS IF ENACTMENT OF THE REZONING REQUEST BY CITY COUNCIL.
 - SEVEN DAYS OF WITHDRAWING REZONING APPLICATION.
 - SEVEN DAYS OF DENIAL OF REZONING REQUEST BY CITY COUNCIL.
 7. FAILURE TO REMOVE THE SIGN(S) WITHIN THE ALLOTTED TIME PERIOD MAY REQUIRE THE REMOVAL OF THE SIGN BY THE CITY AND/OR PROSECUTION AT THE OWNER'S EXPENSE.



LEGEND



811
Know what's below.
Call before you dig.

THE LOCATION OF EXISTING UNDERGROUND UTILITIES ARE SHOWN AS AN APPROXIMATE ONLY AND ARE NOT BEING RESPONSIBLY IDENTIFIED BY THE OFFICE OR ITS REPRESENTATIVE. THE CONTRACTOR SHALL VERIFY THE EXACT LOCATION OF ALL EXISTING UTILITIES BEFORE COMMENCING WORK, AND ACCEPT TO BE FULLY RESPONSIBLE FOR ANY AND ALL DAMAGES WHICH MIGHT BE OCCASIONED BY THE CONTRACTOR'S FAILURE TO EXACTLY LOCATE AND PREPARE ANY AND ALL UNDERGROUND UTILITIES.

ATWELL
866.850.4200 www.atwell-group.com
TWO TOWNE SQUARE, SUITE 700
3000 W. HAWTHORNE AVENUE
TROY, MI 48068
248.447.2000

SECTION 35	TOWN 1 NORTH, RANGE 8 EAST
	CITY OF NOVI
	OAKLAND COUNTY, MICHIGAN

WASH ME PROPERTIES, LLC.
REZONING EXHIBIT & SIGN LAYOUT

DATE	NOVEMBER 12, 2016
REVISIONS/SUBMITTALS	

RECEIVED
DEC 10 2018
CITY OF NOVI
COMMUNITY DEVELOPMENT

SCALE: 1"=30'
DRAWN BY: JC
CHECKED BY: EM
PROJECT MANAGER: MMC
JOB #: 17003282
FILE CODE: CP
SHEET NO. 1

ALTA/NSPS LAND TITLE SURVEY



Know what's below.

THE LOCATIONS OF EXISTING UNDERGROUND UTILITIES ARE SHOWN IN AN APPROXIMATE WAY ONLY AND HAVE NOT BEEN INDEPENDENTLY VERIFIED BY THE OWNER OR ITS REPRESENTATIVE. THE CONTRACTOR SHALL BE RESPONSIBLE FOR THE EXACT LOCATION OF ALL EXISTING UTILITIES BEFORE COMMENCING WORK AND SHALL BE FULLY RESPONSIBLE FOR ANY AND ALL DAMAGES WHICH MAY BE OCCURRED BY THE CONTRACTOR'S FAILURE TO EXACTLY LOCATE AND PRESERVE ANY AND ALL UNDERGROUND UTILITIES.

NOTICE: CONSTRUCTION SITE SAFETY IS THE SOLE RESPONSIBILITY OF THE CONTRACTOR. NEITHER THE OWNER NOR THE ENGINEER SHALL BE EXPECTED TO ASSURE ANY RESPONSIBILITY FOR SAFETY OF THE WORK OF PERSONS ENGAGED IN THE WORK OF ANY NEARBY STRUCTURES, OR OF ANY OTHER PERSONS.

COPYRIGHT © 2018 ATWELL, LLC. NO REPRODUCTION SHALL BE MADE WITHOUT THE PRIOR WRITTEN CONSENT OF ATWELL, LLC.



SECTION 35
TOWN 1 NORTH, RANGE 8 EAST
CITY OF NOVI
OAKLAND COUNTY, MICHIGAN
LOCATED IN

CLIENT: WASHME PROPERTIES, LLC
ALTA/NSPS LAND TITLE SURVEY
DATE: 2/6/2018

SCALE: 0 15 30
1" = 30 FEET

REVISIONS

DR. SW | CH. ME

P.M. J. CECIL

BOOK

JOB 17003282

SHEET NO. 1 OF 2



LEGEND

○ SCOR	SECTION CORNER
× FIP	SET CAPPED IRON ROD
○ FIP	FOUND NAIL
○ FIP	FOUND IRON PIPE
○ FIP	FOUND IRON ROD
○ FIP	EXISTING SIGN
○ FIP	EXISTING LIGHT POLE
○ FIP	BURIED GAS MARKER
○ FIP	BURIED ELECTRIC MARKER
○ FIP	BURIED TELEPHONE MARKER
○ FIP	EXISTING WATER VALVE
○ FIP	EXISTING HYDRANT
○ FIP	EXISTING BOLLARD
○ FIP	EXISTING MANHOLE/CATCH BASIN
○ FIP	EXISTING CULVERT
○ FIP	EXISTING ELECTRIC TRANSFORMER
○ FIP	EXISTING TREE W/ TAG
○ FIP	EXISTING GROUND ELEVATION RECORD
○ FIP	MEASURED
○ FIP	EXISTING RAILROAD TRACKS
○ FIP	BOUNDARY LINE
○ FIP	ADJACENT BOUNDARY LINE
○ FIP	SECTION LINE
○ FIP	APPROXIMATE UNDERGROUND WATER LINE
○ FIP	APPROXIMATE UNDERGROUND GAS LINE
○ FIP	UNDERGROUND STORM LINE
○ FIP	UNDERGROUND SANITARY LINE
○ FIP	UNDERGROUND TELEPHONE LINE
○ FIP	EXISTING CURB AND GUTTER
○ FIP	EXISTING GROUND CONTOUR
○ FIP	POINT OF BEGINNING

- ### NOTES:
- 1. BEARINGS ARE BASED ON MICHIGAN STATE PLANE COORDINATES (NAD83), SOUTH ZONE, GROUND DISTANCES, INTERNATIONAL FEET. MEASURED BEARINGS AS SHOWN DIFFER FROM RECORD TITLE BEARINGS, VERTICAL DATUM IS BASED ON NAVD83.
 - 2. THE SITE SHOWN HEREON IS LOCATED WITHIN ZONE AE (AREAS DETERMINED TO BE WITHIN THE 1% ANNUAL CHANCE FLOODPLAIN) AND ZONE X (AREAS DETERMINED TO BE OUTSIDE OF THE 0.2% ANNUAL CHANCE FLOODPLAIN) ACCORDING TO MAP NUMBER 26125C0528F OF THE FLOOD INSURANCE RATE MAP, EFFECTIVE DATE SEPTEMBER 29, 2006.
 - 3. WATER MAIN, STORM SEWER, AND SANITARY SEWER UTILITY STRUCTURES HAVE BEEN FIELD LOCATED WHERE VISIBLE WITHIN THE TOPOGRAPHIC SURVEY LIMITS. UTILITY AND AS-BUILT MAPS HAVE BEEN REQUESTED, BUT NOT ALL MAPS HAVE BEEN RECEIVED AT DATE OF THIS SURVEY. FRANCHISE UTILITY MAPS HAVE BEEN REQUESTED FROM THE APPROPRIATE FRANCHISE COMPANY, BUT NOT ALL MAPS HAVE BEEN RECEIVED AT DATE OF SURVEY. FRANCHISE UTILITY STRUCTURES HAVE BEEN FIELD LOCATED WHERE VISIBLE WITHIN THE TOPOGRAPHIC SURVEY LIMITS.
 - NOTE: THE SURVEYOR MAKES NO GUARANTEES THAT THE UNDERGROUND UTILITIES SHOWN COMPRISE ALL SUCH UTILITIES IN THE AREA, EITHER IN-SERVICE OR ABANDONED.
 - NOTE TO THE CLIENT, INSURER, AND LENDER - SOURCE INFORMATION FROM PLANS AND MARKINGS WILL BE COMBINED WITH OBSERVED EVIDENCE OF UTILITIES PURSUANT TO SECTION 5.611, TO DEVELOP A VIEW OF THE UNDERGROUND UTILITIES. HOWEVER, LACKING EXCAVATION, THE EXACT LOCATION OF UNDERGROUND FEATURES CANNOT BE ACCURATELY, COMPLETELY, AND RELIABLY DEPICTED. IN ADDITION, IN SOME JURISDICTIONS, 811 OR OTHER SIMILAR UTILITY LOCATE REQUESTS FROM SURVEYORS MAY BE IGNORED OR RESULT IN AN INCOMPLETE RESPONSE, IN WHICH CASE THE SURVEYOR SHALL NOTE ON THE PLAT OR MAP HOW THIS AFFECTED THE SURVEYOR'S ASSESSMENT OF THE LOCATION OF THE UTILITIES. WHERE ADDITIONAL OR MORE DETAILED INFORMATION IS REQUIRED, THE CLIENT IS ADVISED THAT EXCAVATION AND/OR A PRIVATE UTILITY LOCATE REQUEST MAY BE NECESSARY.
 - 4. CERTIFICATION TO ALTA/NSPS LAND TITLE SURVEY ONLY APPLIES TO THAT PORTION OF PARCEL 1 AS SURVEYED AND DEPICTED HEREON.

0.68 ACRE PARCEL TO BE REZONED

DESCRIPTION OF A 0.68 ACRE PARCEL (TRANSFER PARCEL) OF LAND LOCATED IN THE NORTHWEST 1/4 OF SECTION 35, T1N, R8E, CITY OF NOVI, OAKLAND COUNTY, MICHIGAN

COMMENCING AT THE NORTHWEST CORNER OF SECTION 35, T1N, R8E, CITY OF NOVI, OAKLAND COUNTY, MICHIGAN; THENCE S02°19'48"E (RECORDED AS S00°15'00"W) 2445.60 FEET ALONG THE WEST LINE OF SAID SECTION 35; THENCE N86°53'52"E 350.00 FEET; THENCE N02°19'48"W 10.00 FEET FOR A PLACE OF BEGINNING; THENCE CONTINUING N02°19'48"W 206.75 FEET ALONG THE EAST LINE OF THE WEST 350 FEET OF THE SOUTHWEST 1/4 OF THE NORTHWEST 1/4 OF SAID SECTION 35; THENCE N86°53'52"E 143.00 FEET; THENCE S02°19'48"E 206.75 FEET; THENCE N86°53'52"W (RECORDED AS S89°28'40"W) 143.00 FEET TO THE PLACE OF BEGINNING, BEING A PART OF PARCEL 22-35-101-038 IN THE NORTHWEST 1/4 OF SAID SECTION 35, CONTAINING 0.68 ACRES OF LAND, MORE OR LESS, BEING SUBJECT TO EASEMENTS, CONDITIONS, RESTRICTIONS AND EXCEPTIONS OF RECORD, IF ANY.

- ### SOURCE BENCHMARKS:
- CITY OF NOVI BM 3511
ELEVATION: 803.41 (NAVD88)
 - CITY OF NOVI BM 3512
ELEVATION: 832.57 (NAVD88)
- ### SITE BENCHMARKS:
- BM #1: MAG NAIL ON NW FACE 10" COTTONWOOD LOCATED ON NORTH TOP OF BANK, NEAR SOUTHEAST CORNER OF PARKING LOT, ±90' WEST OF WESTERLY RAILROAD RIGHT OF WAY
ELEVATION: 828.98' (NAVD88)
 - BM #2: CHISELED SQUARE ON NORTH TOP OF LIGHT POLE BASE LOCATED ±46' SOUTH & ±80' EAST OF SOUTHEAST CORNER OF CARWASH BUILDING
ELEVATION: 830.97' (NAVD88)



Squeaky Shine Car Wash

Novi, MI
Novi, Rd

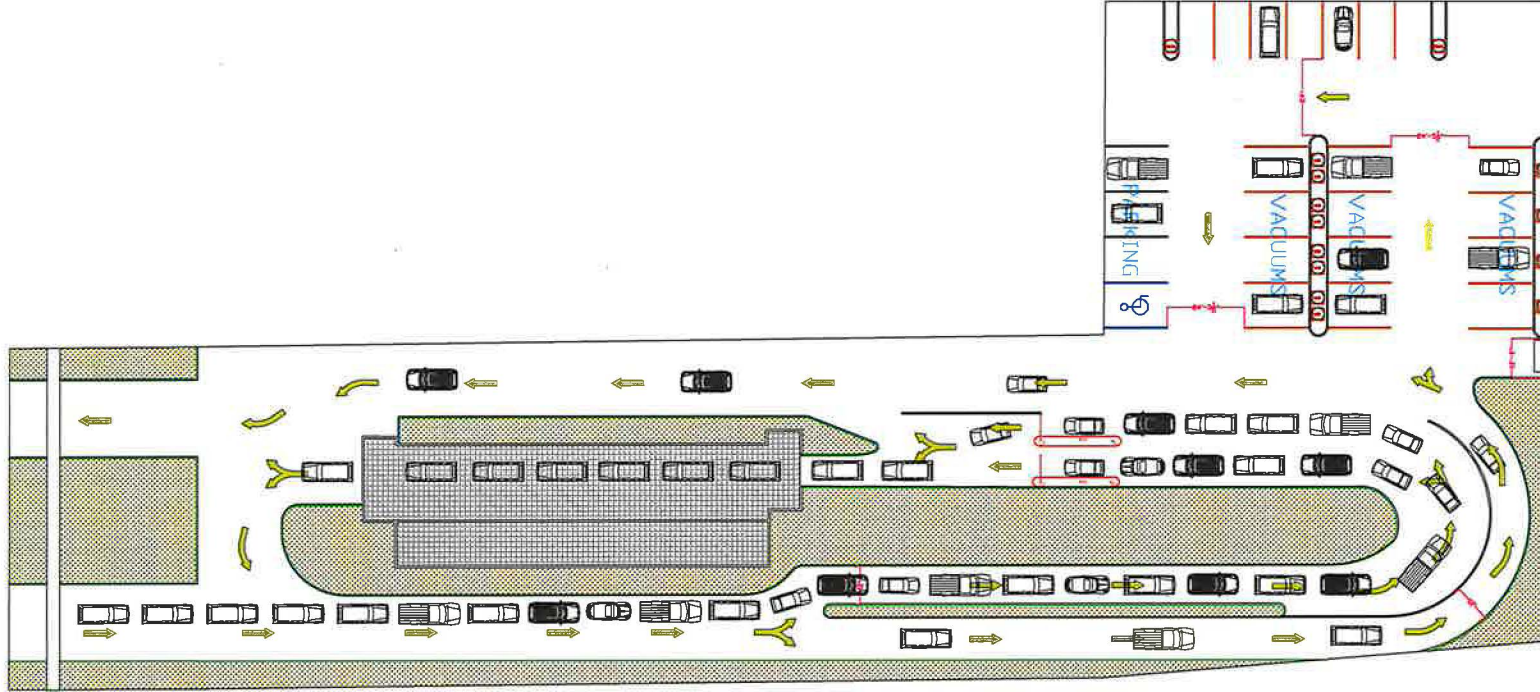

BELANGER, INC. STANDARD NOTE TO CONTRACTORS:
 THIS SET OF DRAWINGS AND DOCUMENTS IS INTENDED AS A SET OF GUIDELINES FOR THE PROJECT. THEY MUST BE READ TO INCORPORATE ALL APPLICABLE FEDERAL, STATE AND LOCAL CODES INCLUDING FEDERAL AIAA REQUIREMENTS. THIS SET ASSUMES THAT THERE ARE NO UNUSUAL SOIL CONDITIONS. THE FAILURE OF THIS CONDITION MAY REQUIRE SIGNIFICANT CHANGES TO THESE DOCUMENTS. IT IS THE RESPONSIBILITY OF THE GENERAL CONTRACTOR TO CONFORM TO ALL APPLICABLE CODES AND TO INFORM THE OWNER/ARCHITECTS OF ANY QUESTIONS OR CLARIFICATIONS WHICH ARE REQUIRED. CONTRACTORS ARE ASSUMED TO KNOW ALL OBSERVANCE CONDITIONS.
 THIS DRAWING IS AND SHALL REMAIN THE PROPERTY OF BELANGER, INC. NO REPRODUCTION OR ALTERATION OF THIS DRAWING WITHOUT THE EXPRESS WRITTEN PERMISSION OF BELANGER, INC. IS PROHIBITED.



Novi Rd. Car Wash
 BELANGER DRAWINGS
 SITE PLAN

DATE:	8/26/18
AWK:	
CHECKED:	
DATE:	
APPROVED:	
DATE:	
SCALE:	AS SHOWN
PAPER:	11x17

REV	DATE	ENGR	APPR	DESCRIPTION
				1/180 COPY IS INTENDED TO BE 27"x34" WHEN PRINTED SCALES ARE NOT ACCURATE FOR ANY OTHER SIZE

PROJECT #:
 Revision # 2

SHEET #:

REZONING NARRATIVE

RE-ZONING REQUEST

**BELANGER CAR WASH
21510 NOVI ROAD, NOVI, MICHIGAN 48375**

PREPARED BY:



**Atwell, LLC.
12745 23 Mile Road, Suite 200
Shelby Township, MI 48315**

PREPARED FOR:



**Wash Me Properties, LLC.
22700 Heslip Drive
Novi, MI 48375**

December 6, 2018



Wash Me Car Wash
21510 Novi Road
Novi, MI 48375

Subject: Parcel 22-35-101-036 Proposed Rezoning

Dear Board Members,

On behalf of Wash Me Properties, LLC., please accept this letter and enclosed exhibits as a formal request for rezoning 0.68 acres of parcel 22-35-101-036 (3.40 acres) from I-1 to B-3. An exhibit depicting the existing parcels and zoning designation and the proposed parcels and zoning designation are enclosed for your reference.

Pending approval of the rezoning, it is the intent of Wash Me Properties, LLC., to obtain a parcel line adjustment to modify parcel 22-35-101-006 to consist of a 1.56 acre parcel zoned entirely as B-3 to facilitate expansion of the services at the existing car wash, including vacuum stations, increased stacking for the existing wash, and additional parking. To aid in your review, enclosed are a completed rezoning application, exhibit of the property requested to be re-zoned, survey, rezoning traffic study, and a sign location plot plan.

We appreciate your prompt consideration of this request. Feel free to contact me at 248-447-2000 with questions or concerns.

Sincerely,

A handwritten signature in black ink, appearing to read "Mike McPherson", with a long horizontal flourish extending to the right.

Michael McPherson, P.E.
Atwell, LLC

PLANNING COMMISSION MINUTES
FEBRUARY 27, 2019 DRAFT
EXCERPT

by an outside agency, so they are all operational but we are to a point now where we're trying to find replacement parts and they're harder to find because they've stopped making them. So we have it teed up for next year's budget, it's a price tag around \$300,000 so that's why it's a little harder to have in this year's budget. But everything has been confirmed by our Fire Administration that they are perfectly operational, just in terms of planning it has to be done in the next year.

Member Hornung said thank you. I think it's extremely important to protect those that protect us, and I really appreciate that that's been given that type of care and consideration. Thank you very much.

Member Maday said just so you know, that was brought up in the meeting in great detail.

Member Greco said I'd like to make a motion.

Motion made by Member Greco and seconded by Member Avdoulos.

ROLL CALL VOTE TO ADOPT THE 2019-2025 CAPITAL IMPROVEMENT PROGRAM MOTION MADE BY MEMBER GRECO AND SECONDED BY MEMBER AVDOULOS.

Motion to adopt the 2019-2025 Capital Improvement Program as presented. Motion carried 5-0.

2. SQUEAKY SHINE CAR WASH JZ18-50 with Rezoning 18.727

Public hearing at the request of Squeaky Shine LLC for Planning Commission's recommendation to City Council for rezoning of property in Section 35, located on the east side of Novi Road between Eight Mile Road and Nine Mile Road from I-1 (Light Industrial) to B-3 (General Business). The subject property is approximately 0.68 acres.

Planner Bell said the petitioner is requesting a Zoning Map Amendment for a 0.68-acre portion of property located northeast of the Novi Road and Galway Drive intersection (Section 35) from I-1, Light Industrial, to B-3, General Business. The applicant states that the rezoning request is necessary to expand the existing car wash facility at 21510 Novi Road, which is already zoned B-3. The building has operated for several years as a car wash demonstration facility for Belanger, a Novi-based company that designs and manufactures car wash components and systems. The facility would be repurposed as a retail car wash that would be open to the public.

The applicants indicate that they would purchase a portion of the property to the east to make room for vacuum stations, longer vehicle stacking space, and additional parking. The parcels would be combined after purchase. Provided is a conceptual plan of what that might look like.

Since this is not a PRO, they are not bound to what is shown in the concept drawing included in your packet. Once zoned B-3, the property could be developed now or in the future for other uses permitted within the General Business district. A list of uses is provided in your packet.

Planner Bell said the Future Land Use Map identifies this property and parcels to the north

and south as Industrial Research Development Technology. The parcels to the west along Novi Road are planned for Local Commercial. To the east are the railroad tracks, with a single-family neighborhood on the opposite side of the tracks. In this area of Novi Road, there are vehicle service facilities, small strip retail centers, sit down restaurants, and an office complex. Single-family residential uses are located on the opposite of Novi Road.

A wetland is indicated on the City's Wetland map over much of the subject area. However, the applicant provided a wetland delineation report that showed wetlands do not extend into the subject area. This report was reviewed by the City's Environmental consultant during a pre-application review of the project and they concurred with the findings.

Engineering review found that there are adequate public utilities to serve the parcel, and that the impacts from B-3 uses are expected to be about the same or less than potential I-1 uses.

Traffic consultants have reviewed the anticipated traffic generation from the proposed rezoning and found the impacts are not expected to degrade the surrounding roadway network below acceptable levels.

Planner Bell said the Master Plan and Zoning Committee considered this proposal in January, and the Committee members raised some concerns about the noise from the vacuum stations. In response, the applicant has provided information about the noise generated by the potential vacuum units. Staff has measured the distance to the closest homes in Chase Farms subdivision, which would be approximately 250-300 feet from the vacuum units. Without accounting for any dampening effects of the trees and raised railroad tracks, we anticipate the receiving lots would experience a noise level of about 44.5 decibels, which is below the Ordinance limit of 60 decibels during day time hours. Additional review of sound impacts will be looked at during the site plan review process, as well.

Staff recommends approval of the rezoning request. The Planning Commission is asked tonight to hold the public hearing and approve or deny the rezoning request. Representing the project tonight are Ryan Belanger and Gregory Richard from Squeaky Shine, and engineer Michael McPherson from Atwell, to answer any questions you may have.

Mike McPherson, with Atwell, said I'm the Engineering consultant for this project and I'm joined by the gentleman from Belanger, the owners of the current car wash and the applicant for the project. I think Lindsay did a great job introducing the rezoning request and hitting on all the key items. We've worked hand in hand with Staff here for several months now getting to this point. So we don't have a whole lot to add, but we'd be happy to answer any questions you may have.

Chair Pehrson asked if there was anyone in the audience that wished to address the Planning Commission regarding this project. Seeing no one, he said I believe we have some correspondence.

Member Greco said we do have some correspondence received on the City response form. The first is from Dan Devendorf, 43564 Westridge Lane, who is opposed to repurpose

this as a working car wash because of potential traffic congestion, additional sense of over-commercialization in the area, negative impact of value on contiguous real estate and light displays creating uncomfortable and unacceptable environment. Next we have another objection from Chris Coulter, 43586 Westridge Lane, who lives across the street and does not want additional noise and traffic from an expanded facility. And then we have a support from Joseph Widak, 44880 Thornapple Lane in Northville, the commercial property owner to the north, he supports the expansion and the request from the petitioners because the property is landlocked and only has value to the commercial property owners, and it backs up to the railroad.

Chair Pehrson closed the public hearing and turned it over to the Planning Commission for their consideration.

Member Avdoulos said the Master Plan and Zoning Committee did review this and after walking through it with the applicants, we didn't really see an issue. The car wash was always there and will operate as a car wash, so we're not changing the use. The lanes are actually being pushed back on the one site plan, so there's actually more lane there to negate the worry of back-ups onto Novi Road. There's not much you can really do with that property, so they're offering the vacuums in the back.

And then we had the concern also that was brought forward regarding noise. The document was provided that the decibel levels as they get further away from the property and actually towards the railroad tracks will dissipate to 40 decibels, which is what we require. Plus, this is a heavily commercial area anyway. The noise that is generated by the trains is going to be more-so than what is generated by vacuum cleaners. So we felt that it's just an appropriate improvement to the existing facility. So what I would like to do is offer a motion.

Motion made by Member Avdoulos and seconded by Member Greco.

Member Hornung said I have a question. In the packet, we only had one review of traffic as far as an analysis. Is there any other data that we have as far as automated car washes that might give us a clearer picture as far as the amount of traffic that might be generated in the PM hours?

Planner Bell said we do not have any additional information. That will be looked at again during the site plan review, which is more particular to the actual use that is being proposed on site.

Member Hornung said ok, thank you. And one other question. I became a little unclear – it seemed the description at the beginning was saying that the current facility does not do public car washes. Is that correct?

Gregory Richard, with Squeaky Shine, said so previously, it was operating as a test facility for Belanger, Inc. which is a car wash manufacturing company. Recently that company was sold, and in the sale we kept ownership of the car wash with the intent to make it open to the public. For Belanger, Inc., they would fly customers in that were looking at the car wash equipment products and we would demonstrate to them how it operates and how customers take in that whole experience and sell the equipment.

Ryan Belanger, with Squeaky Shine, said this would be purely retail, separating from the manufacturer. At its max capacity, the previous owner about ten years ago at this parcel had about 200,000 cars per year. With extending the stacking, that would be our dream to at least reach that number. So if anything, the improvement for this is going to help us with the capacity of traffic.

Member Hornung said thank you, thanks for clarifying that because it almost seemed like we were saying earlier that the car wash was already operating as a car wash, and it is not. So I just wanted to clarify that before we make a motion.

Member Avdoulos said I'm sorry, it was operating as a car wash and they maintained it as a manufacturer for car wash equipment. And then it's going to be back to a public car wash. So it really hasn't changed use, per se, but you're correct that it was public up until ten years ago.

Mr. Richard said about 2013 was when we shut it down for the test facility. But during the period of time that we used it to demonstrate, every time that we had a customer in, we would open it up to the public and they could drive in and get free car washes, as well.

Member Greco said and just to comment, this was a car wash that I used to use regularly, so I'm welcoming the car wash hopefully coming back, honestly. And just as far as the expansion, I don't ever recall there really being an issue on Novi Road as far as it backing up and it being a deep lot. I don't see it being an issue, and for the area around there I think it's necessary. It was there for a while and it was what people used, and now unless you're going to work and using 696, the closest one unless you want to go to the one that does back up onto the road in Northville, you have to go up to the Novi Road area, which you probably want to avoid unless you're shopping. So that's why I support it.

Member Maday said I just wanted to say, given that it's not going to affect any of the residences nearby, this allows you to use a piece of property that otherwise might not be developed into something useful. So I am definitely in support of this.

ROLL CALL VOTE TO RECOMMEND APPROVAL OF REZONING MOTION MADE BY MEMBER AVDOULOS AND SECONDED BY MEMBER GRECO.

In the matter of the request of Squeaky Shine Car Wash, JZ18-50, with Zoning Map Amendment 18.727, motion to recommend approval to City Council to rezone the subject property from I-1 (Light Industrial) to B-3 (General Business) for the following reasons:

- 1. The Master Plan for Land Use objective to foster a favorable business climate is fulfilled by allowing an existing business to expand,**
- 2. The Master Plan for Land Use objective to support and strengthen existing businesses is fulfilled by allowing an existing business to expand and develop a vacant parcel,**
- 3. This is a reasonable alternative to the recommended land use and will be consistent with zoning to the west,**
- 4. Noise data supplied by the applicant that the proposed use will not cause significant impacts on nearby residential neighborhoods,**
- 5. There is no negative impact expected on public utilities as stated in the Engineering memo,**

6. **The Rezoning Traffic Impact Study has demonstrated that the proposed rezoning will not degrade the level of service of the local road network below acceptable levels, and**
7. **The rezoning provides an opportunity for a long-standing business to expand at their current location, with the submittal of a site plan anticipated once the rezoning is approved.**

Motion carried 5-0.

3. INTERIOR ENVIRONMENTS PARKING EXPANSION JSP18-51

Public hearing at the request of Interior Environments for approval of Preliminary Site Plan, Wetland Permit and Stormwater Management Plan. The subject property is located in Section 17 north of Grand River Avenue, south of Twelve Mile Road, and east of Wixom Road, and is zoned B-3, General Business. The applicant is proposing to expand the parking lot for an additional 20 spaces, which includes modifications to the existing stormwater detention basin.

Planner Bell said the subject property is in Section 17, north of Grand River and south of Twelve Mile Road, east of Wixom Road. The parcel is 1.36 acres and is the existing site of Interior Environments. The property is zoned B-3, General Business, as are the properties to the east and west. The area to the south across Grand River is zoned I-1, Light Industrial. The City of Wixom is located on the north side of Twelve Mile, which is developed with an automobile dealership. The Future Land Use map indicates Community Commercial for this property and those on either side. South of Grand River is planned for Office, Research, Development & Technology uses.

There is an existing stormwater management pond on the site that falls under the Wetland and Watercourses regulations of the City, which will be impacted by the changes proposed to the site. These modifications require the minor wetland/watercourse permit. Wetlands review recommends approval.

The applicant is proposing to expand their parking lot to accommodate an additional 20 parking spaces due to high parking demand. Existing access to Grand River and Twelve Mile would not change from the current configuration. No changes are proposed to the existing building.

New parking would be added on the north and west sides of the building. The drive aisle and some parking spaces would encroach into the Twelve Mile Right-of-Way. Twelve Mile is under the jurisdiction of the Road Commission for Oakland County. The applicant has provided an email from RCOC indicating that they would allow the encroachment. As designed, Zoning Board of Appeals variances will be required for reduced parking setbacks along both Grand River and Twelve Mile. An additional variance will be necessary for an end island that is longer than required.

Planner Bell said the applicant requests several Planning Commission landscape waivers as well. These include a waiver to allow one bay of parking spaces to exceed the 15 space maximum, with 19 spaces proposed; a waiver to not provide greenbelt berms along Grand River and Twelve Mile, as the proposed layout does not allow room for them and a substitute hedge is provided; a waiver to reduce the required greenbelt on Grand River; a waiver to not provide the required greenbelt on Twelve Mile; a waiver for the shortage of subcanopy trees along Twelve Mile; a waiver to not provide street trees along

PLANNING REVIEW



PLAN REVIEW CENTER REPORT

January 9, 2019

Planning Review

Squeaky Shine Car Wash
JZ18-50 with Rezoning 18.727

PETITIONER

Squeaky Shine LLC

REVIEW TYPE

Rezoning Request from I-1 (Light Industrial) to B-3 (General Business)

PROPERTY CHARACTERISTICS

Section	35	
Site Location	East of Novi Road, North of Eight Mile Road (21510 and pt. 21530 Novi Road)	
Site School District	Northville Public School District	
Site Zoning	RA One Family Residential	
Adjoining Zoning	North	I-1 Light Industrial District
	East	RA One Family Residential
	West	OST: Office Service Technology
	South	RA One Family Residential
Current Site Use	Car Wash test facility, rear portion Vacant	
Adjoining Uses	North	Retail center; Auto Service
	East	Single Family Residences
	West	Single Family Residences
	South	Vacant
Site Size	0.68 Acres	
Plan Date	November 12, 2018	

PROJECT SUMMARY

The petitioner is requesting a Zoning Map amendment for a 0.68 acre portion of property located northeast of the corner of Novi Road and Galway Drive intersection (Section 35) from I-1 (Light Industrial) to B-3 (General Business). The applicant states that the rezoning request is necessary to expand the existing car wash facility at 21510 Novi Road, which is already zoned B-3. They would purchase a portion of the property to the east to make room for vacuum stations, longer vehicle stacking space, and additional parking. This portion of property would need to be rezoned to B-3 and the parcels combined to accommodate the car wash.

The applicant provided a concept plan with this request, which indicates that the existing car wash building itself would not be modified. However, since this is not a PRO they are not bound to what is shown in the concept drawing. The building has operated for several years as a car wash demonstration facility for Belanger, a Novi-based company that designs and manufactures car wash components/systems. Belanger plans to split the facility off to be operated by a derivative company as a retail car wash that would be open to the public.

The applicant met with planning staff to discuss the process and determined to apply for a traditional rezoning. As this is not a PRO (Planned Rezoning Overlay) rezoning, the applicant is not bound to develop a specific plan or use after rezoning has been approved. The proposed rezoning category is not supported by the Future Land Use map recommendation for the subject property.

MASTER PLAN FOR LAND USE

The Future Land Use Map of the 2016 City of Novi Master Plan for Land Use identifies this property and properties adjacent to north, south and east as Industrial Research Development Technology. Property to the west is identified as Local Commercial.

The proposal would follow objectives listed in the Master Plan for Land Use including the following:

1. Objective: Retain and support the growth of existing businesses and attract new businesses to the City of Novi.
2. Objective: Provide and maintain adequate water and sewer service for the City's needs.

DEVELOPMENT POTENTIAL

The piece to be rezoned is currently an undeveloped part of a larger parcel that is developed and used as an auto service facility. The piece on it's own does not have frontage to a public street. Development under the current I-1 zoning could result in the construction of an approximately 7,175 square foot medical office building on the 0.68 acre site, taking into account required setbacks and parking. Under the proposed B-3 zoning district, the applicant's traffic consultant estimates a maximum of 7,525 square foot medical office building and the required parking could be built. As a "maximum impact" scenario, once combined with the car wash site, the 1.56 acre parcel could be developed as a 4,250 square foot fast food restaurant with a drive through window in the B-3 District. This use would require special land use permit approval from the City of Novi.

EXISTING ZONING AND LAND USE

The following table summarizes the zoning and land use status for the subject property and surrounding properties.

Land Use and Zoning: For Subject Property and Adjacent Properties

	Existing Zoning	Existing Land Use	Master Plan Land Use Designation
Subject Property	I-1 Light Industrial	Vacant land	Industrial research development and technology. (uses consistent with Light Industrial Districts, I-1)
Northern Parcels	I-1 Light Industrial District	Parking lot for Auto Service	Industrial research development and technology. (uses consistent with Light Industrial Districts, I-1)
Southern Parcels	P-1 Vehicular Parking	Parking Lot for Restaurant	Industrial research development and technology. (uses consistent with Light Industrial Districts, I-1)
Eastern Parcel	I-1 Light Industrial	Vacant land (stormwater pond)	Industrial research development and technology. (uses consistent with Light Industrial Districts, I-1)
Western Parcels	B-3 General Business	Retail Center, Car wash	Local Business (uses consistent with B-1 District)

COMPATIBILITY WITH SURROUNDING LAND USE

The surrounding land uses are shown in the above chart. The compatibility of the proposed rezoning with the zoning and uses on the adjacent properties should be considered by the Planning Commission in making the recommendation to City Council on the rezoning request.

The property directly **north** of the subject area is currently functioning as an automobile service facility. The current zoning map indicates I-1 for the property.

Directly to the **south** of the subject property is used as a restaurant parking lot and zoned P-1.

The property to the **west** of the subject property is a retail center and the existing car wash and is zoned B-3.

To the **east** of the subject property is a stormwater management pond (zoned I-1) and the CSX Railroad tracks, beyond which is an existing single family neighborhood. At the time of Preliminary Site Plan Review, the Planning Commission should review the plan carefully to insure that there will be no negative impacts (such as additional noise, lighting) on the residential property to the east.

Future Land Use map indicates Industrial Research Development Technology for the subject property and the properties to the north, south and east. Local commercial uses are shown to the west.



Future Land Use

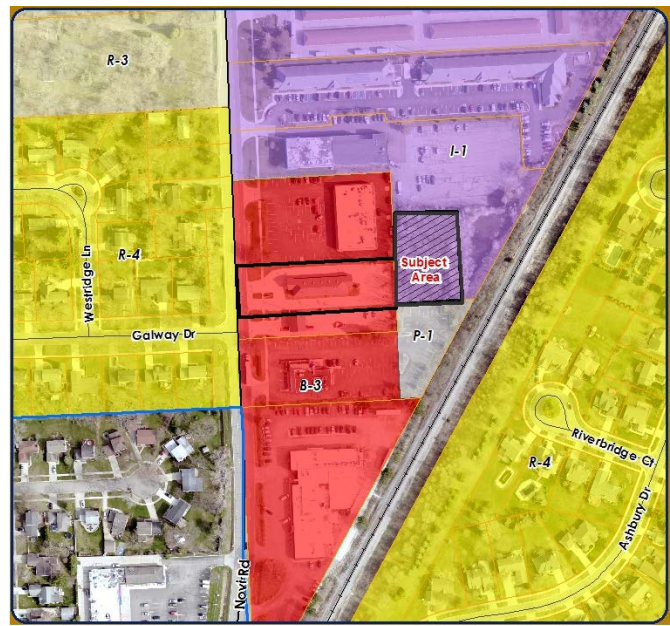

Existing Zoning

COMPARISON OF ZONING DISTRICTS

The following table provides a comparison of the current (I-1) and proposed (B-3) zoning classifications.

	I-1 Zoning (Existing)	B-3 Zoning (Proposed)
Principal Permitted Uses	1. Professional office buildings, offices and office sales and service activities 2. Accessory buildings, structures and uses customarily incident to the above	1. Retail businesses use 2. Retail business service uses 3. Dry cleaning establishments, or pick-up stations, dealing directly with the

	<p>permitted uses</p> <ol style="list-style-type: none"> 3. Publicly owned and operated parks, parkways and outdoor recreational facilities 4. Public or private health and fitness facilities and clubs 5. Medical offices, including laboratories and clinics <p>Permitted when not adjacent to residential (otherwise Special Land Use):</p> <ol style="list-style-type: none"> 6. Laboratories 7. Research, testing, design and development, technical training, and design of pilot or experimental products 8. Data processing and computer centers 9. Warehousing and wholesale establishments 10. Manufacturing 11. Industrial office sales, service and industrial office related uses 12. Trade or industrial schools 13. Laboratories experimental, film or testing 14. Greenhouses 15. Off-street parking lots 16. Publicly utility buildings, telephone exchange buildings, electrical transformer stations and substations, and gas regulator stations, other than outside storage and service yards 17. Public or private indoor recreation facilities 18. Private outdoor recreation facilities 19. Pet boarding facilities 20. Veterinary hospitals or clinics 21. Motion picture, television, radio and photographic production facilities 22. Other uses of a similar and no more objectionable character to the above uses 23. Accessory buildings and uses customarily incident to any of the above permitted uses 	<p>consumer</p> <ol style="list-style-type: none"> 4. Business establishments which perform services on the premises 5. Professional services 6. Retail business or retail business service establishments 7. Professional or medical offices, including laboratories 8. Fueling station 9. Sale of produce and seasonal plant materials 10. Auto wash 11. Bus passenger stations 12. New and used car salesroom, showroom, or office 13. Other uses similar to the above uses 14. Tattoo parlors 15. Publicly owned and operated parks, parkways and outdoor recreational facilities 16. Accessory structures and uses customarily incident to the above permitted uses 17. Public or private health and fitness facilities and clubs 18. Microbreweries 19. Brewpubs
<p>Special Land Uses</p>	<ol style="list-style-type: none"> 1. Metal plating, buffing, polishing and molded rubber products 2. Uses which serve the limited needs of an industrial district (subject to Section 4.43), as follows: <ol style="list-style-type: none"> a. Financial institutions, unions, union halls, and industrial trade schools or industrial clinics b. Industrial tool and equipment sales, service, storage and distribution c. Eating and drinking establishments and motels 3. Automobile service establishment 4. Self-storage facilities 	<ol style="list-style-type: none"> 1. Outdoor space for exclusive sale of new or used automobiles, campers, recreation vehicles, mobile homes, or rental of trailers or automobiles 2. Motel 3. Business in the character of a drive-in or open front store 4. Veterinary hospitals or clinics 5. Plant materials nursery 6. Public or private indoor and private outdoor recreation facilities 7. Mini-lube or oil change establishments 8. Sale of produce and seasonal plant materials outdoors

	5. Retail sales activities 6. Central dry cleaning plants or laundries 7. Railroad transfer, classification and storage yards 8. Tool, die, gauge and machine shops 9. Storage facilities for building materials, sand, gravel, stone, lumber, storage of contractor's equipment and supplies 10. Municipal uses 11. Motion picture, television, radio and photographic production facilities 12. Outdoor space for parking of licensed rental motor vehicles 13. Accessory buildings, structures and uses customarily incident to any of the above permitted uses	9. Restaurant in the character of a fast food carryout, drive-in, fast food drive-through, or fast food sit-down
Minimum Lot Size	Determined by off-street parking, loading, greenbelt screening, yard setback or usable open space	Determined by off-street parking, loading, greenbelt screening, yard setback or usable open space requirements
Minimum Lot Width	Determined by off-street parking, loading, greenbelt screening, yard setback or usable open space requirements	Determined by off-street parking, loading, greenbelt screening, yard setback or usable open space requirements
Building Height	40 feet	30 feet
Building Setbacks	Front: 75 feet Side: 10 feet Rear: 20 feet	Front: 30 feet Side: 15 feet Rear: 20 feet

INFRASTRUCTURE

Engineering

The Staff Engineer has reviewed the rezoning request and expressed no concerns regarding sanitary sewer capacity and available water capacity. The impacts of B-3 land use on the utilities in this area are expected to be less than utility demands if developed under I-1 uses.

Traffic

City Traffic consultants reviewed the Rezoning Traffic Impact Study provided by the applicant and indicated that the maximum amount of additional traffic that would be generated by the site is not expected to degrade the existing roadway network levels of service below acceptable limits. Traffic supports the rezoning request. Traffic also noted that additional trip generation estimates should be performed at the time of site plan in order to better assess the expected traffic impacts due to the lack of data points available in the ITE Trip Generation Manual, 10th edition. See the traffic review letter for additional information.

NATURAL FEATURES

There is a significant area of regulated wetland noted on the City's wetland map. The applicants have performed a wetland survey of the property and have concluded that there are no wetlands or watercourses located within the 0.68 acre portion of the site, which has been confirmed by the City's wetland consultant.

As this is not a PRO (Planned Rezoning Overlay) rezoning, the applicant is not bound to develop a specific plan after rezoning has been approved. Staff is unable to determine the extent of impact on the 25-foot natural features setback associated with the stormwater basin just east of the area to be rezoned. More thorough review will be performed at the time site plan submittal and necessary permits will have to be obtained. The applicant is encouraged to propose minimum or no impacts to the buffer areas.



RECOMMENDATION

Approval of the **Rezoning is recommended** because

- The rezoning request fulfills objectives of the Master Plan for Land Use by fostering a favorable business climate and growth of an existing business.
- The rezoning will be consistent with zoning to the west.
- The rezoning provides an opportunity to utilize a vacant parcel.
- The rezoning is not expected to negatively impact public utilities or traffic in the area.

The rezoning is the first step in the process; the applicant will still need to seek the required approvals from Planning Commission for the Preliminary Site Plan, Authorization to Encroach the 25-Foot Natural Features Setback (if applicable), and Stormwater Management Plan depending on the requirements as determined at the time of site plan review.

NEXT STEP: MASTER PLANNING AND ZONING COMMITTEE

This Rezoning request is scheduled to go before the **Planning Commission's Master Planning and Zoning Committee** on **January 23, 2019** for consideration. This committee considers requests that do not conform with the recommended land use categories of the Master Plan. **Please provide the initial plans submitted in a PDF format.**

If the applicant has any questions concerning the above review or the process in general, do not hesitate to contact me at 248.347.0484 or lbell@cityofnovi.org.

Lindsay Bell – Planner

ENGINEERING REVIEW

MEMORANDUM



TO: LINDSAY BELL, PLANNER
FROM: KATE RICHARDSON, PLAN REVIEW ENGINEER
SUBJECT: SQUEAKY SHINE CAR WASH - REVIEW OF REZONING IMPACT ON PUBLIC UTILITIES
DATE: JANUARY 3, 2019

The Engineering Division has reviewed a rezoning request for the 0.68 acres located north of 8 Mile Road and east of Novi Road. The applicant is requesting to rezone 0.68 acres of a 3.40 acre parcel, 22-35-101-036 from the existing zoning of Light Industrial (I-1) to General Business (B-3). The Master Plan for Land Use indicates a future land use of Industrial Research Development Technology for this location.

Utility Demands

A residential equivalency unit (REU) equates to the utility demand from one single family home. If the area were developed under the current zoning, demand on the utilities for the site would be 5.0 REUs per acre for Factory. The applicant intends to propose an expansion to the existing car wash, including vacuum stations, increased space for stacking at the existing wash, and additional parking. This would have an approximate utility demand of 1.8 REUs per acre.

Water System

The site is located within the Lower Water Pressure District. Water service is currently available from an eight-inch water main that runs parallel to Novi Road. The proposed rezoning would have minimal impact on available capacity, pressure and flows in the City's water distribution system.

Sanitary Sewer

The site is located within the Interceptor Sewer District. Sanitary service is available by connection to an existing eight-inch sanitary sewer that runs parallel to Novi Road. The proposed rezoning is not anticipated to have an apparent impact on the capacity of the downstream sanitary sewer within the City's infrastructure.

Summary

The requested rezoning will result in utility demands that are approximately equal to or less than the utility demand if the property were to be developed under the current zoning. Therefore, the rezoning is expected to have negligible impact on utility demands.

cc: Ben Croy, P.E.; Water & Sewer Senior Manager
Barb McBeth, AICP; City Planner
George Melistas; Engineering Senior Manager
Darcy Rechten, P.E.; Construction Engineer

TRAFFIC REVIEW



AECOM
27777 Franklin Road
Southfield
MI, 48034
USA
aecom.com

Project name:
JZ19-50 Squeaky Shine Rezoning Traffic Impact
Study Review

From:
AECOM

Date:
January 7, 2019

To:
Barbara McBeth, AICP
City of Novi
45175 10 Mile Road
Novi, Michigan 48375

CC:
Sri Komaragiri, Lindsay Bell, George Melistas, Darcy
Rechtien, Hannah Smith

Memo

Subject: Squeaky Shine Rezoning Traffic Impact Study (RTIS) Review

The rezoning traffic impact study was reviewed to the level of detail provided and AECOM **recommends approval** for the RTIS based on the information that was provided with the submittal.

GENERAL COMMENTS

1. The applicant consulted Tetra Tech to perform a rezoning traffic impact study for the proposed expansion of the Squeaky Shine Car Wash site located on the east side of Novi Road between Eight Mile and Nine Mile Roads.
2. Novi Road at the location of the site is under the jurisdiction of the Road Commission for Oakland County (RCOC) and experiences an average traffic volume of 13,200 vehicles per day.
3. The site is currently zoned I-1, Light Industrial, and the applicant is requesting a B-3 general business.

TRIP GENERATION

1. The study examines the trip generation under both existing and proposed zoning classifications.
2. The City of Novi Zoning Ordinance allows office buildings, sales and service activities, publicly owned and operated parks, parkway and outdoor recreational facilities, public or private health and fitness facilities, medical offices including laboratories and clinics under I-1 zoning. Retail businesses, professional services, medical offices including laboratories, fueling stations, car sales, car washes, microbreweries, public or private health and fitness facilities and clubs, publically owned and operated parks, parkways, and outdoor recreational facilities, and other similar uses are allowed under B-3 zoning.
3. The estimated maximum number of trips was calculated for existing zoning (I-1) using one land use:
 - a. Medical Office (7,175 SF)
 - b. Atwell LLC provided estimated building sizes based on the site size, setback, and parking requirements.
4. Based on the assumed building sizes, the maximum number of trips that would result under I-1 zoning are:
 - a. 188 daily trips (medical office)
 - b. 21 AM peak-hour trips (Medical Office)
 - c. 26 PM peak-hour trips (Medical Office)
5. The estimated maximum number of trips was calculated for proposed zoning (B-3) using two land uses:

- a. Medical Office (7,525 SF)
 - b. Fast-Food Restaurant with a Drive-Through Window (4,250 SF)
 - c. Atwell LLC provided estimated building sizes based on the site size, setback, and parking requirements.
6. Based on the assumed building sizes, the maximum number of trips that would result under B-3 zoning are:
- a. 202 daily trips (Medical Office)
 - b. 22 AM peak-hour trips (Medical Office)
 - c. 28 PM peak-hour trips (Medical Office)
 - d. 2,002 daily trips (Fast-Food Restaurant with a Drive-Through Window)
 - e. 22 AM peak-hour trips (Fast-Food Restaurant with a Drive-Through Window)
 - f. 28 PM peak-hour trips (Fast-Food Restaurant with a Drive-Through Window)
7. The estimated number of trips produced by the proposed Squeaky Shine expansion are:
- a. n/a daily trips
 - b. n/a AM peak-hour trips
 - c. 75 PM peak-hour trips
 - d. The preparer used the ITE Trip Generation, 10th edition to calculate existing/proposed car wash trips. This is not advised by the ITE Trip Generation Handbook, 3rd edition, due to the lack of study sites for the Car Wash facility type. The Handbook instead recommends local data collection, which, due to the nature of the proposed rezoning to accommodate an expansion rather than a new development, should not prove to be too difficult. *The preparer should update the RTIS to be present more accurate data.*

CONCLUSIONS AND RECOMMENDATIONS

1. As indicated in the RTIS, the proposed rezoning from I-1 to B-3 would not be expected to significantly increase the number of expected trips during the peak periods.
2. The proposed Squeaky Shine Car Wash expansion land use would be expected to generate fewer trips than what *could* be built under the existing I-1 zoning as well as fewer trips than is allowable under B-3 zoning. However, the applicant should consider collecting their own trip generation counts for a similar car wash on a roadway with comparable traffic levels, due to the lack of data points in the ITE Trip Generation Manual, 10th edition.

Should the City or applicant have questions regarding this review, they should contact AECOM for further clarification.

Sincerely,

AECOM



Josh A. Bocks, AICP, MBA
Senior Transportation Planner/Project Manager



Patricia A. Thompson, EIT
Traffic Engineer

NOISE IMPACT INFORMATION



ONE COMPANY.
INFINITE SOLUTIONS.

February 5, 2019

Squeaky Shine Car Wash Re-Zone
City of Novi, MI
Noise Assessment

Dear Board Members -

The purpose of this letter is to provide supplemental information based on conversation at the recent Master Plan Committee meeting. During the meeting, the issue of noise produced by vacuums was raised.

As supplemental information, attached to this document are examples of a potential vacuum units along with associated noise levels. Within 10' of the unit the decibel level is around 74. However, the noise level dissipates quickly and at 40-feet from a vacuum the noise level is approximately 62 decibels. Per the City zoning ordinance, the sound level decibel limits for a residential (receiving) district is 60 decibels during day time hours. The nearest homes will be approximately 200-feet from the subject parcel with a wooded area, detention pond, and railroad track in between. Based on these factors along with the anticipated noise production it appears that noise from future vacuum units will be below the standard decibel levels and not impact the residences east of the subject site.

Based on this information, we respectfully request that the proposed re-zoning be placed on the February 27, 2019 Planning Commission public hearing for consideration of approval.

Thank you for your time and consideration of this matter. Please feel free to contact us with questions or comments at (586) 786-9800.

Sincerely,

A handwritten signature in black ink, appearing to read "Michael McPherson".

Michael McPherson, P.E. Atwell, LLC

VACUUMS

AUTOVAC

Industrial
Vacuum & Air Systems

600 Series 4 Bearing

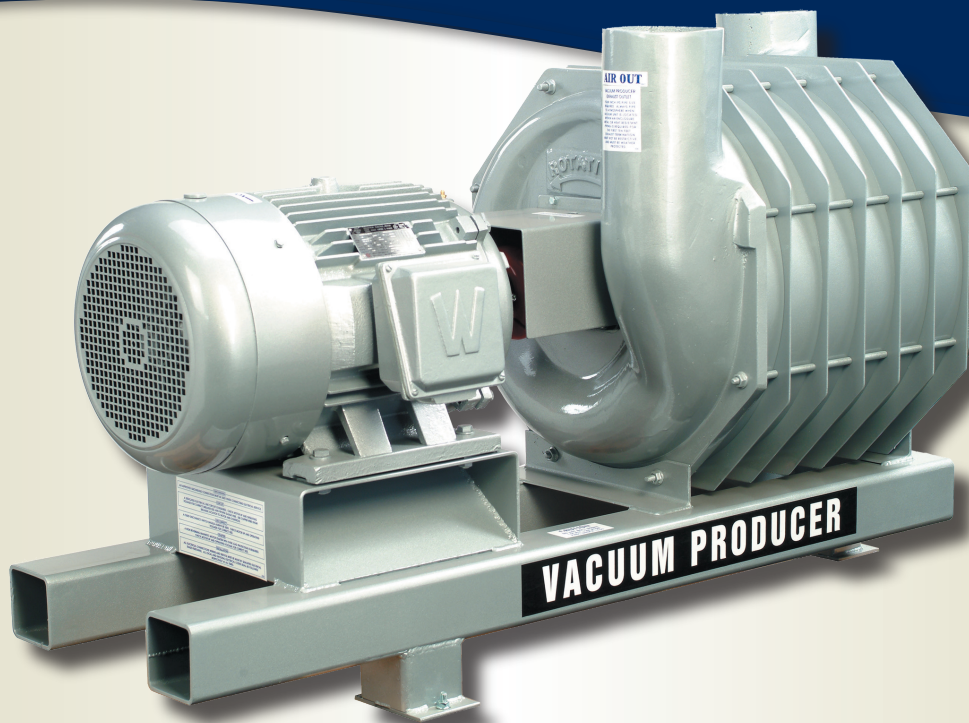

At the heart of every AutoVac central cleaning system is our powerful **Centrifugal Vacuum Producer**. The 600 Series turbine is a multistage exhauster available in 25 and 40 hp depending on your needs. It's engineered for years of reliable performance

with very little maintenance. We manufacture our 600 Series in-house in accordance with strict production standards. Combine the 600 Series with an AutoVac separator, engineered piping, and customized electronic motor controls for the most reliable vacuum system available.

888-628-8682

email: sales@autovacinc.com



www.autovacinc.com

600 Series, 6" Standard Vacuum Producer 4 Bearing with Pedestal Mounted Motor

Standard 3 Phase	Model: Standard Performance, 3600 RPM*				
Total Simultaneous Users 15'x1/2" Dia. Vac Hose	HP	Frame Dimensions	Weight lbs.	Decibels at 10ft.	Part #
8-10 Users	25HP 3600 RPM	60"	950	72	216-1001
10-12 Users	30HP 3600 RPM	60"	1000	74	216-2001
12-14 Users	40HP 3600 RPM	66"	1450	76	216-3001

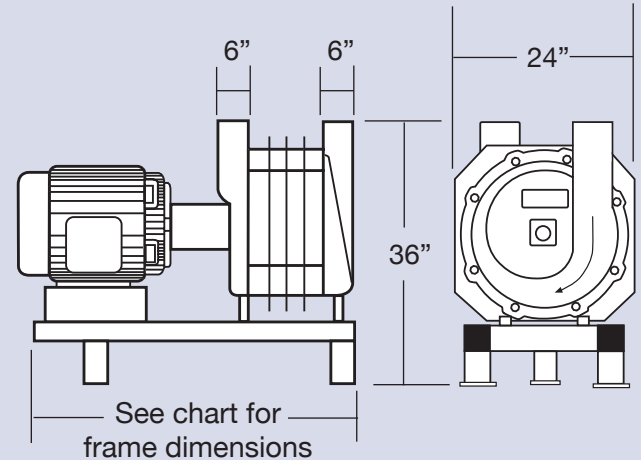

* Please consult your AutoVac sales professional for 50 Hz, 575 volt, and high altitude applications above 3000'. Explosion proof motors available.

PERFORMANCE INLET CURVES CENTRIFUGAL EXHAUSTER

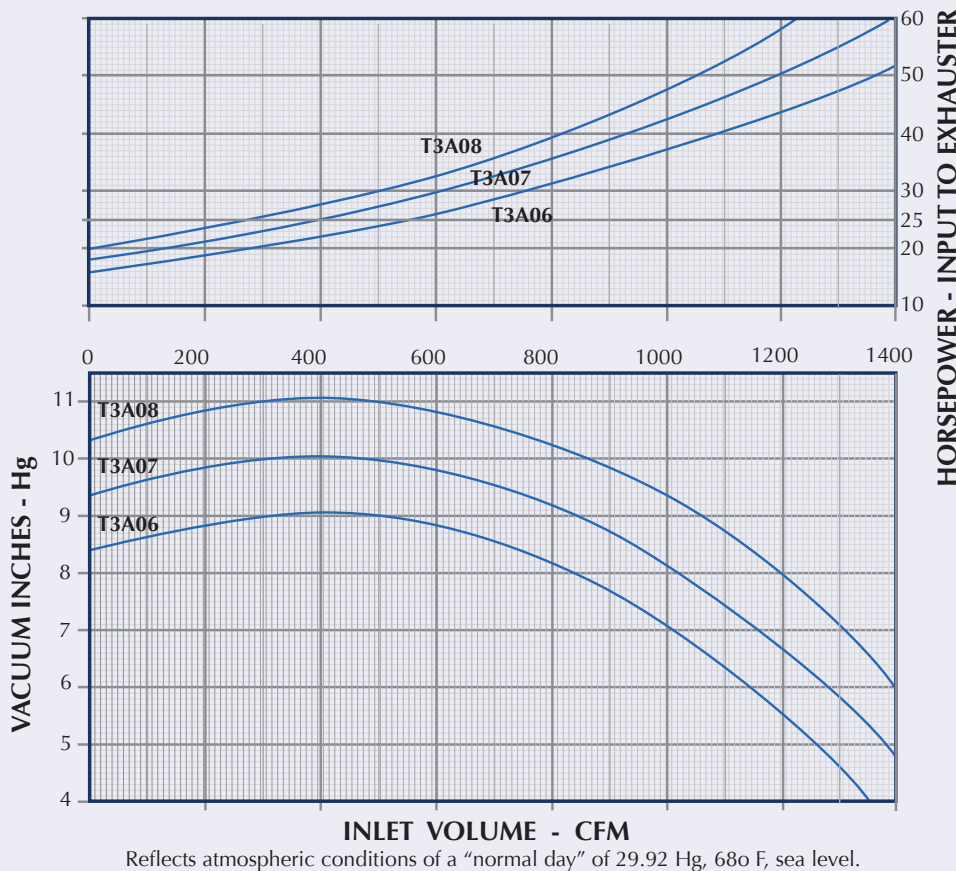

Features

- Turbine blower casing is housed between two 1/2" thick 356 alloy aluminum head castings for strength, durability and heat dissipation.
- Impellers are 6061-T6 aircraft grade aluminum and dynamically balanced to ensure operation below 1.5 mils at 3,600 RPMs.
- Directional-controlled inlet and outlet air openings accelerate airflow and improve performance.
- Two-bolt outboard flange bearings are self-aligning.
- Extremely durable cast iron TEFC drive motor is aligned at the factory for vibration-free operation.
- SureFit split drive couplings from motor to turbine drive shaft are constructed of durable polyurethane.
- Motors and couplings can be serviced without removing the turbine blower section.
- Sturdy iron rail frame with three point leg design and isolator pads prevent turbine from rocking on uneven mounting surfaces.

STEEL WALL, 18FT HIGH, 150FT LONG

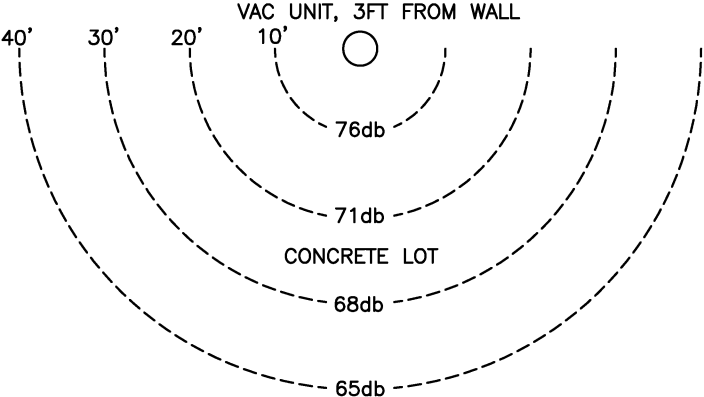

REGULAR VAC MOTOR (2)
PLASTIC DOME

STEEL WALL, 18FT HIGH, 150FT LONG

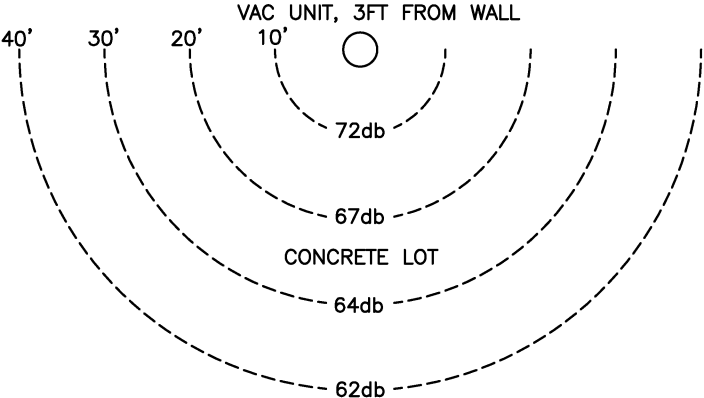

REGULAR VAC MOTOR (2)
STEEL INSULATED DOME

STEEL WALL, 18FT HIGH, 150FT LONG

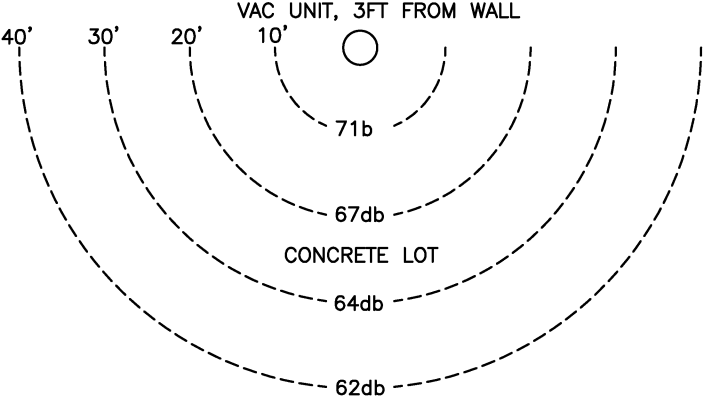

QUIET VAC MOTOR (2)
STEEL INSULATED DOME

TRAFFIC IMPACT STATEMENT



TETRA TECH

November 26, 2018

Mr. Michael McPherson, PE
Atwell, LLC
2 Towne Square, Suite 700
Southfield, Michigan 48076

**Re: Proposed Squeaky Shine Car Wash Expansion Rezoning
Rezoning Traffic Impact Study
City of Novi, Michigan
200-12851-19002**

Dear Mr. McPherson:

Tetra Tech (Tt) has completed our rezoning traffic impact study related to the proposed Squeaky Shine Car Wash expansion located on the east side of Novi Road between Eight Mile and Nine Mile Roads in the City of Novi, Oakland County. The current site is approximately 0.88 acres, zoned B-3 with an approximately 5,250 sq. ft. car wash building, with an adjacent 0.68 acre parcel to the east that is zoned I-1 that is proposed to be zoned B-3 and combined with the existing car wash. The proposed overall plan for the combined approximately 1.56 acre site is to maintain the existing car wash, but provide additional car cleaning vacuums and additional vehicle stacking for the car wash. This rezoning traffic impact study has been completed in accordance with the requirements specified in the City of Novi's Site Plan and Development Manual for traffic impact studies.

Existing Conditions

In the vicinity of the site, Novi Road is a four-lane arterial road (2 northbound lanes, 1 southbound through lane and a continuous southbound right-turn lane) with pavement markings, but without shoulders, under the jurisdiction of the Road Commission for Oakland County (RCOC) with a posted speed limit of 45 MPH.

A recent Average Daily Traffic (ADT) count obtained from the SouthEast Michigan Council Of Governments (SEMCOG) website indicates that the daily traffic volume on Novi Road in the vicinity of the site is approximately 13,200 vehicles per day, with the peak hour being between 5:00 – 6:00 p.m., with a bi-directional volume of approximately 1,300 vehicles per hour. A copy of the Novi Road count from the SEMCOG website is attached to this letter for reference.

The existing car wash site is located within B-3: General Business zoning, which continues south of the site, and the proposed parcel to be rezoned is within I-1: Light Industrial zoning, which continues north of the site. To the west of the site, across Novi Road, the current zoning is a mix of R-3 and R-4 One-Family Residential, as well as to the east (across the railroad tracks) of the site.



Currently the proposed 0.68 acre I-1: Light Industrial parcel to be rezoned B-3: General Business is undeveloped, consisting of woodlands. The existing 0.88 acre B-3: General Business site currently has a car wash on the site, and no changes to the building or the operation are proposed at this time.

Based on information provided by your office, under the current I-1: Light Industrial zoning, you estimated a maximum 7,175 sq. ft. medical office building could be built on the 0.68 acre site, accounting for setbacks and required parking. Under the proposed B-3: General Business zoning, a maximum medical office building size of 7,525 sq. ft. could be built on the 0.68 acre site with the required parking. While a variety of retail and/or restaurant uses could be built under the proposed B-3: General Business zoning, those buildings would be noticeably smaller given the parking requirements for those uses. Also, when just considering the 0.68 acre site location (away from the road and adjacent to railroad tracks) and size, it does not lend itself to these retail/restaurant uses on its own. The concept plans are included in the materials attached to this letter.

However, in order to provide a complete review, an analysis was performed of what would be possible on the entire 1.56 acre site under the exiting/proposed B-3: General Business zoning. Under this scenario, a 4,250 sq. ft. fast-food restaurant with drive-through window service would be feasible. However, this use would require a special land use permit from the City of Novi.

Finally, it should be reiterated that the existing car wash building is not proposed to change with the rezoning and joining of the properties, just additional car cleaning vacuums and additional vehicle stacking for the car wash is proposed. These changes are not anticipated to significantly affect the number of trips to and from the site. The site plan is included in the materials attached to this letter.

Using the information and methodologies specified in the latest version of *Trip Generation (10th Edition)* published by the Institute of Transportation Engineers (ITE), Tt forecast the total weekday, weekday AM and weekday PM peak hour trips associated with the potential uses under the existing and proposed zonings for the site.

Following are tables that summarize our findings.

Table 1
ITE Trip Generation for 0.68 Acre Site, Existing I-1: Light Industrial

Land Use	Land Use Code	Size	AM Peak Hour			PM Peak Hour			Week Day
			In	Out	Total	In	Out	Total	
Medical-Dental Office Building	720	7,175 sq. ft.	16	5	21	7	19	26	188
TOTAL TRIPS			16	5	21	7	19	26	188



Table 2
ITE Trip Generation for 0.68 Acre Site, Proposed B-3: General Business

Land Use	Land Use Code	Size	AM Peak Hour			PM Peak Hour			Week Day
			In	Out	Total	In	Out	Total	
Medical-Dental Office Building	720	7,525 sq. ft.	17	5	22	8	20	28	202
TOTAL TRIPS			17	5	22	8	20	28	202

Table 3
ITE Trip Generation for Entire 1.56 Acre Site, Existing/Proposed B-3: General Business

Land Use	Land Use Code	Size	AM Peak Hour			PM Peak Hour			Week Day
			In	Out	Total	In	Out	Total	
Fast-Food Restaurant with Drive-Through Window	934	4,250 sq. ft.	87	84	171	72	67	139	2,002
TOTAL TRIPS			87	84	171	72	67	139	2,002

Table 4
ITE Trip Generation for Existing/Proposed Car Wash

Land Use	Land Use Code	Size	AM Peak Hour			PM Peak Hour			Week Day
			In	Out	Total	In	Out	Total	
Automated Car Wash	948	5,250 sq. ft.	n / a	n / a	n / a	38	37	75	n / a
TOTAL TRIPS			n / a	n / a	n / a	38	37	75	n / a

n / a – no information provided in Trip Generation, 10th Edition.

The trip generation forecast sheets are attached to this letter.

Conclusions and Recommendations

Under the existing L-1: Light Industrial zoning, the 0.68 acre site is forecast to generate a maximum of 21 trips during the AM peak hour, 26 trips during the PM peak hour and 188 total weekday trips. Under the proposed B-3: General Business zoning, the 0.68 acre site is forecast to generate a maximum of 22 trips during the AM peak hour, 28 trips during the PM peak hour, and 202 total weekday trips. The proposed rezoning of the 0.68 acre parcel would not result in a significant change in trips generated for the site on its own.

When considering the entire 1.56 acre site under B-3: General Business zoning, a 4,250 sq. ft. fast-food restaurant with drive-through window would be possible, with a special land use permit. This use would result in significantly more trips to and from the site; however not all of it would be new



TETRA TECH

traffic, as *Trip Generation Handbook, 3rd Edition* provides pass-by rates for fast-food restaurants with drive-through windows. Pass-by trips are existing traffic on the adjacent roadway network that interrupt their travels to visit the site. Pass-by trips are accounted for by reducing the number of forecast new trips to be added to the roadway network; however, actual driveway volumes are not reduced. *Trip Generation Handbook, 3rd Edition* suggests a 49% AM and 50% PM peak hour pass-by rates for a fast-food restaurant with drive-through window. The pass-by rates should be taken into consideration when comparing fast-food restaurant with drive-through window to the other uses reviewed in this letter.

With the proposed rezoning of the 0.68 acre site to B-3: General Business and combining it with the existing 0.88 acre car wash site, the proposed combined car wash site is not anticipated to experience a noticeable change in trips to and from the site, as the only site changes are to provide additional car cleaning vacuums and additional on-site storage for vehicles entering the car wash.

We trust that this letter fulfills your current transportation needs regarding your site. If you have any questions, please feel free to call our office at (810)-220-2112.

Sincerely,

Kyle W. Ramakers, P.E., PTOE
Transportation Engineer

:be

Attachments

P:\IER\12851\200-12851-19002\SupportDocs\Cals\Traffic\Deliverables\Novi_Car-Wash_Rezone_Letter.docx

NOVI ROAD TRAFFIC COUNT
FROM SEMCOG WEBSITE

Location Info		Count Data Info	
Location ID	2027	Start Date	11/14/2016
Type	LINK	End Date	11/15/2016
Functional Class	-	Start Time	11:00 AM
Located On	NOVI	End Time	11:00 AM
Between	8 Mile AND 9 Mile	Direction	
Direction	2-WAY	Notes	
Community	Novi	Count Source	FO342_____
MPO_ID	16480	File Name	D1114004.prn
HPMS ID		Weather	
Agency	Road Commission for Oakland County	Study	
		Owner	tiacounts

Interval: 60 mins	
Time	Hourly Count
00:00 - 01:00	40
01:00 - 02:00	9
02:00 - 03:00	6
03:00 - 04:00	16
04:00 - 05:00	35
05:00 - 06:00	155
06:00 - 07:00	409
07:00 - 08:00	937
08:00 - 09:00	948
09:00 - 10:00	655
10:00 - 11:00	705
11:00 - 12:00	792
12:00 - 13:00	884
13:00 - 14:00	768
14:00 - 15:00	857
15:00 - 16:00	999
16:00 - 17:00	1081
17:00 - 18:00	1300
18:00 - 19:00	970
19:00 - 20:00	723
20:00 - 21:00	485
21:00 - 22:00	266
22:00 - 23:00	154
23:00 - 24:00	92
TOTAL	13286

TRIP GENERATION FORECASTS

Medical-Dental Office Building (720)

Vehicle Trip Ends vs: 1000 Sq. Ft. GFA
On a: Weekday

Setting/Location: General Urban/Suburban
Number of Studies: 28
Avg. 1000 Sq. Ft. GFA: 24
Directional Distribution: 50% entering, 50% exiting

Vehicle Trip Generation per 1000 Sq. Ft. GFA

Average Rate	Range of Rates	Standard Deviation
34.80	9.14 - 100.75	9.79

Data Plot and Equation

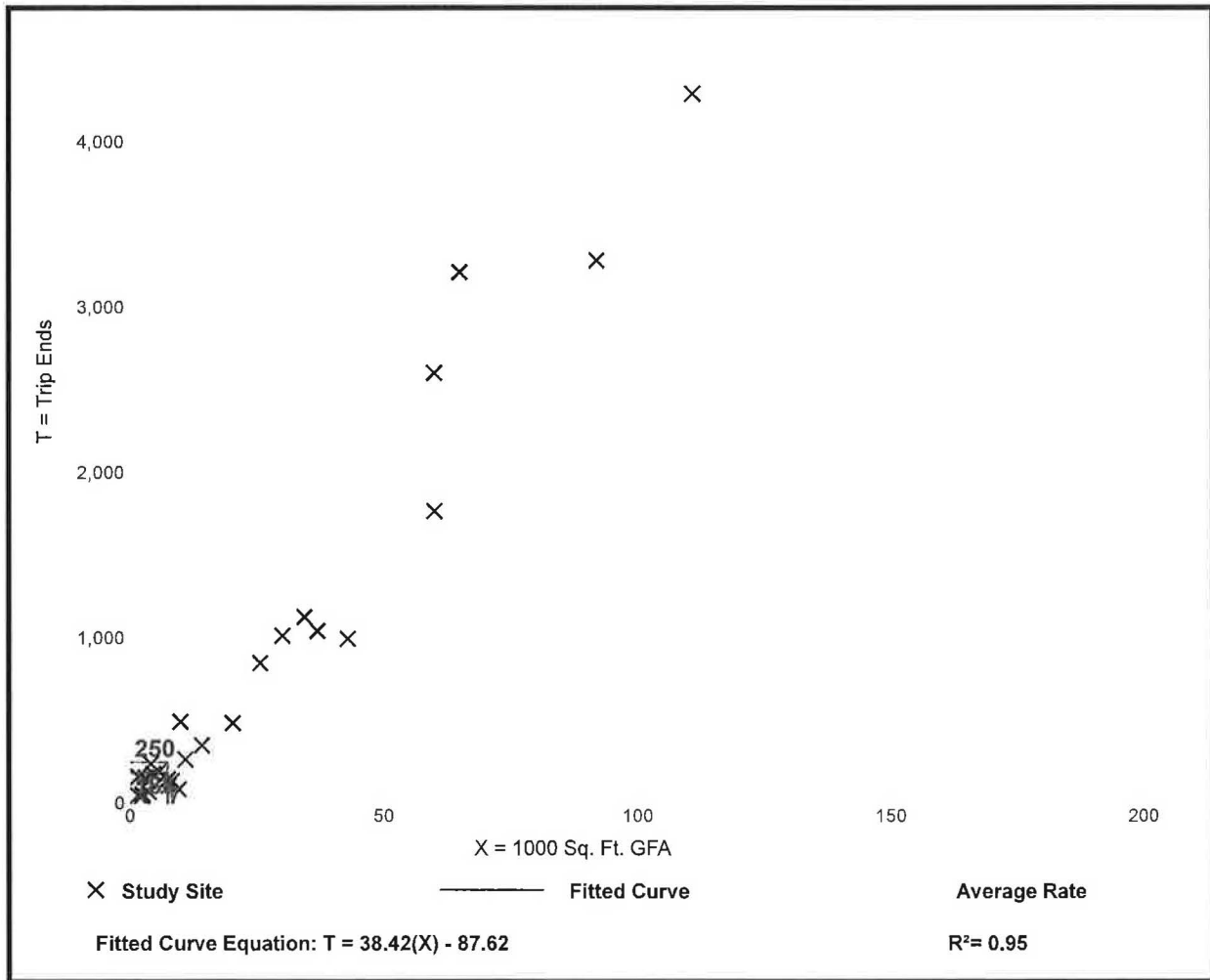

Trip Generation Manual, 10th Edition • Institute of Transportation Engineers

Medical-Dental Office Building (720)

Vehicle Trip Ends vs: 1000 Sq. Ft. GFA
On a: Weekday,
Peak Hour of Adjacent Street Traffic,
One Hour Between 7 and 9 a.m.
Setting/Location: General Urban/Suburban
 Number of Studies: 44
 Avg. 1000 Sq. Ft. GFA: 32
 Directional Distribution: 78% entering, 22% exiting

Vehicle Trip Generation per 1000 Sq. Ft. GFA

Average Rate	Range of Rates	Standard Deviation
2.78	0.85 - 14.30	1.28

Data Plot and Equation

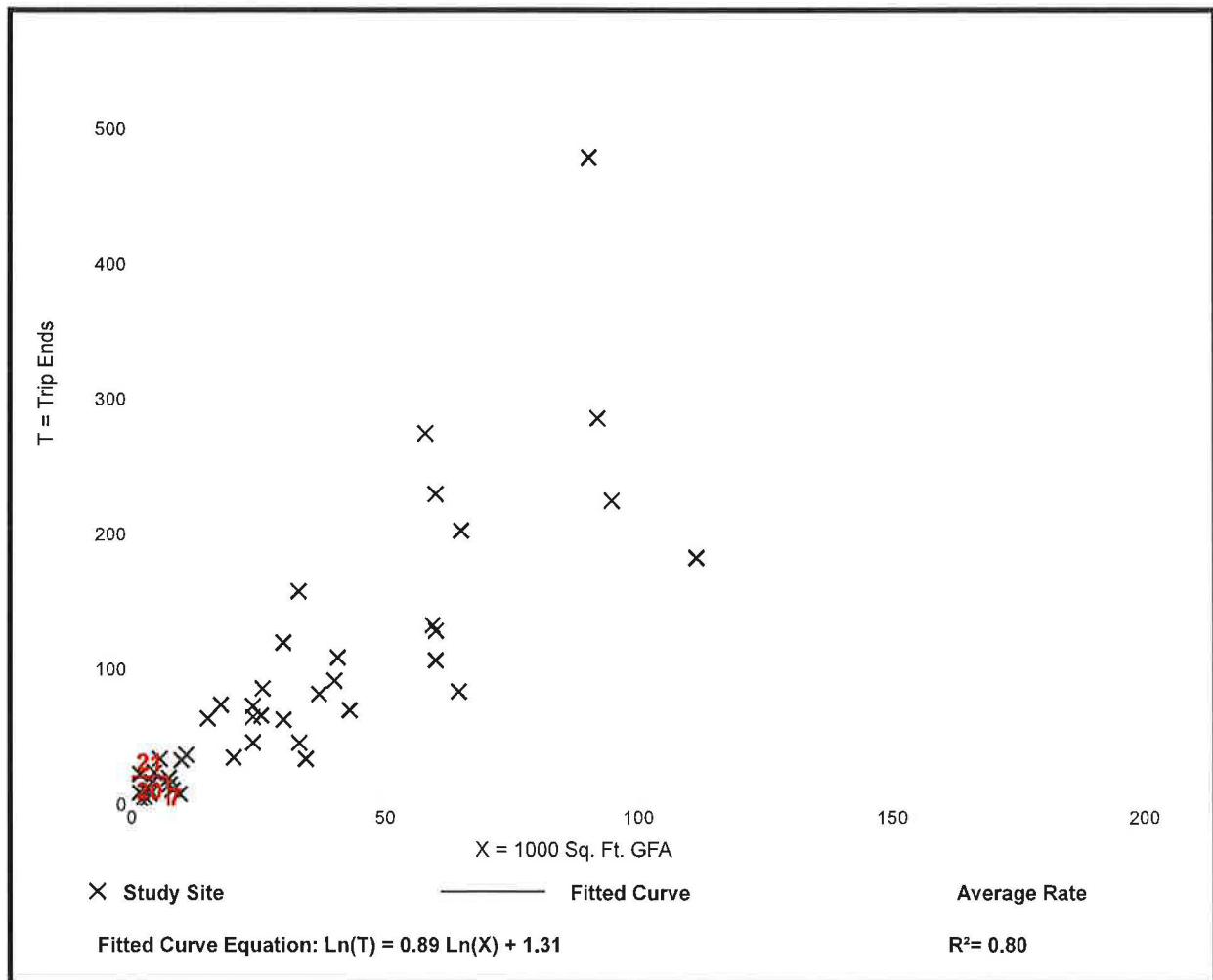

Trip Generation Manual, 10th Edition • Institute of Transportation Engineers

Medical-Dental Office Building (720)

Vehicle Trip Ends vs: 1000 Sq. Ft. GFA
On a: Weekday,
Peak Hour of Adjacent Street Traffic,
One Hour Between 4 and 6 p.m.
Setting/Location: General Urban/Suburban
 Number of Studies: 65
 Avg. 1000 Sq. Ft. GFA: 28
 Directional Distribution: 28% entering, 72% exiting

Vehicle Trip Generation per 1000 Sq. Ft. GFA

Average Rate	Range of Rates	Standard Deviation
3.46	0.25 - 8.86	1.58

Data Plot and Equation

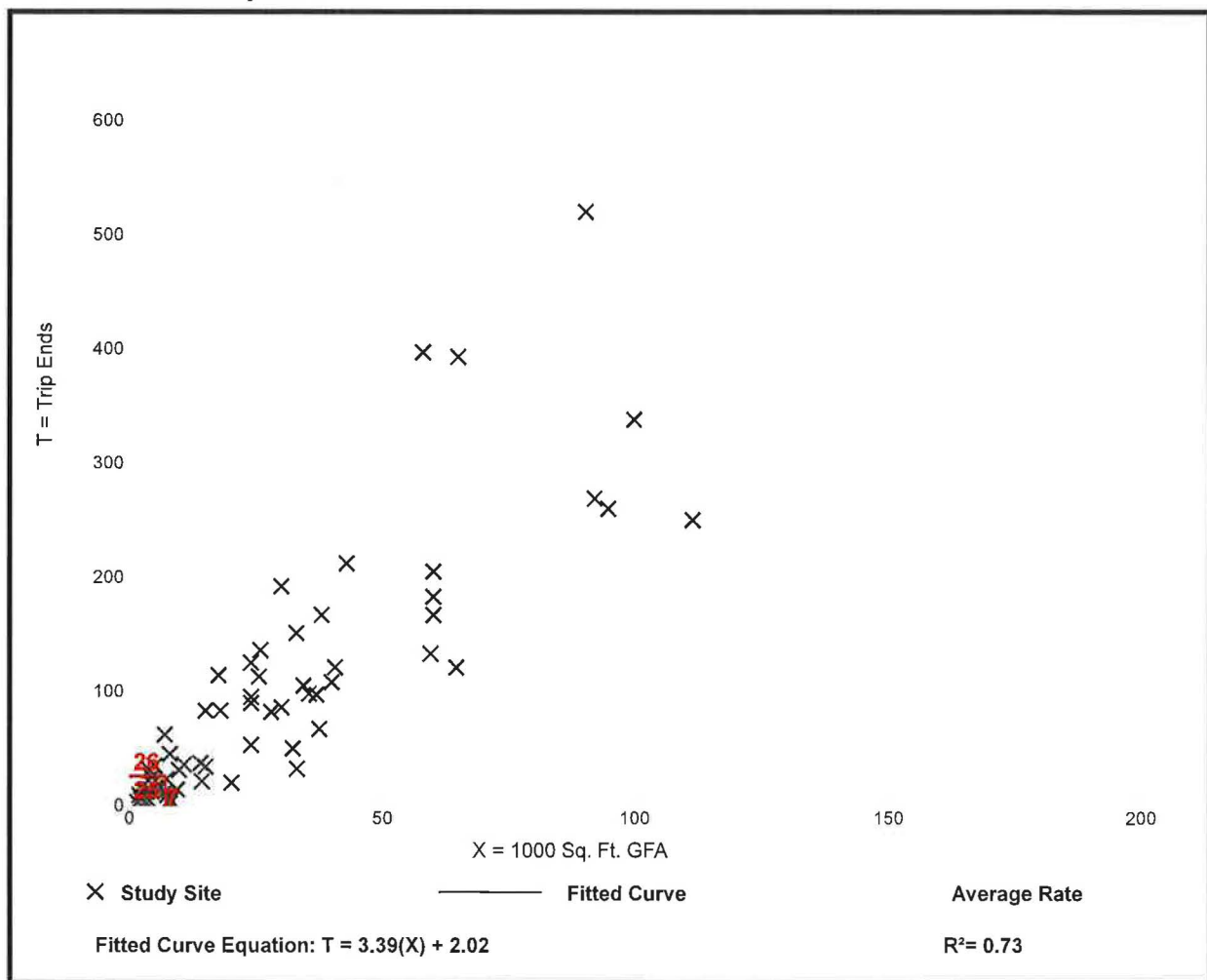

Trip Generation Manual, 10th Edition • Institute of Transportation Engineers

Medical-Dental Office Building (720)

Vehicle Trip Ends vs: 1000 Sq. Ft. GFA
On a: Weekday

Setting/Location: General Urban/Suburban
Number of Studies: 28
Avg. 1000 Sq. Ft. GFA: 24
Directional Distribution: 50% entering, 50% exiting

Vehicle Trip Generation per 1000 Sq. Ft. GFA

Average Rate	Range of Rates	Standard Deviation
34.80	9.14 - 100.75	9.79

Data Plot and Equation

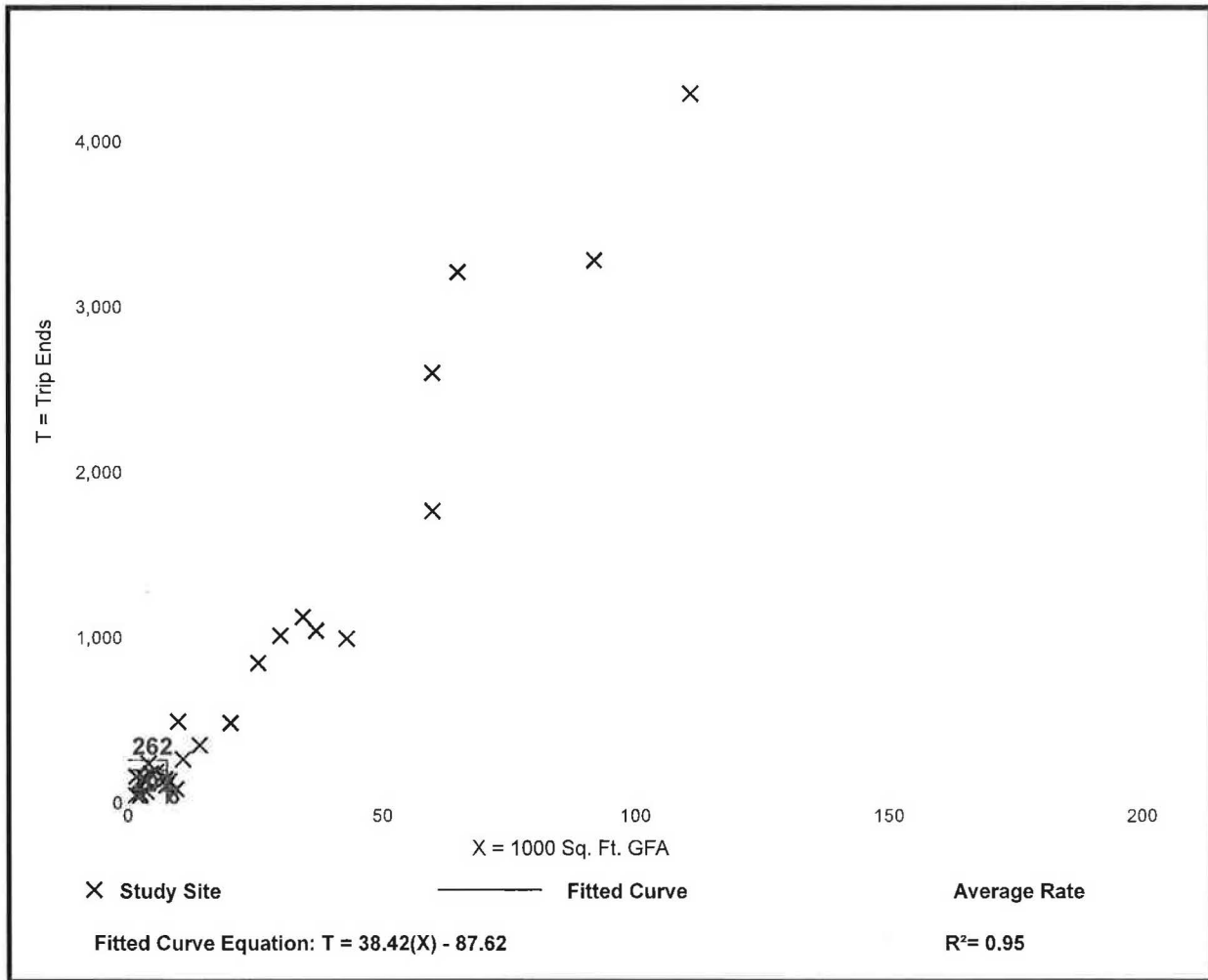

Trip Generation Manual, 10th Edition • Institute of Transportation Engineers

Medical-Dental Office Building (720)

Vehicle Trip Ends vs: 1000 Sq. Ft. GFA
On a: Weekday,
Peak Hour of Adjacent Street Traffic,
One Hour Between 7 and 9 a.m.
Setting/Location: General Urban/Suburban
 Number of Studies: 44
 Avg. 1000 Sq. Ft. GFA: 32
 Directional Distribution: 78% entering, 22% exiting

Vehicle Trip Generation per 1000 Sq. Ft. GFA

Average Rate	Range of Rates	Standard Deviation
2.78	0.85 - 14.30	1.28

Data Plot and Equation

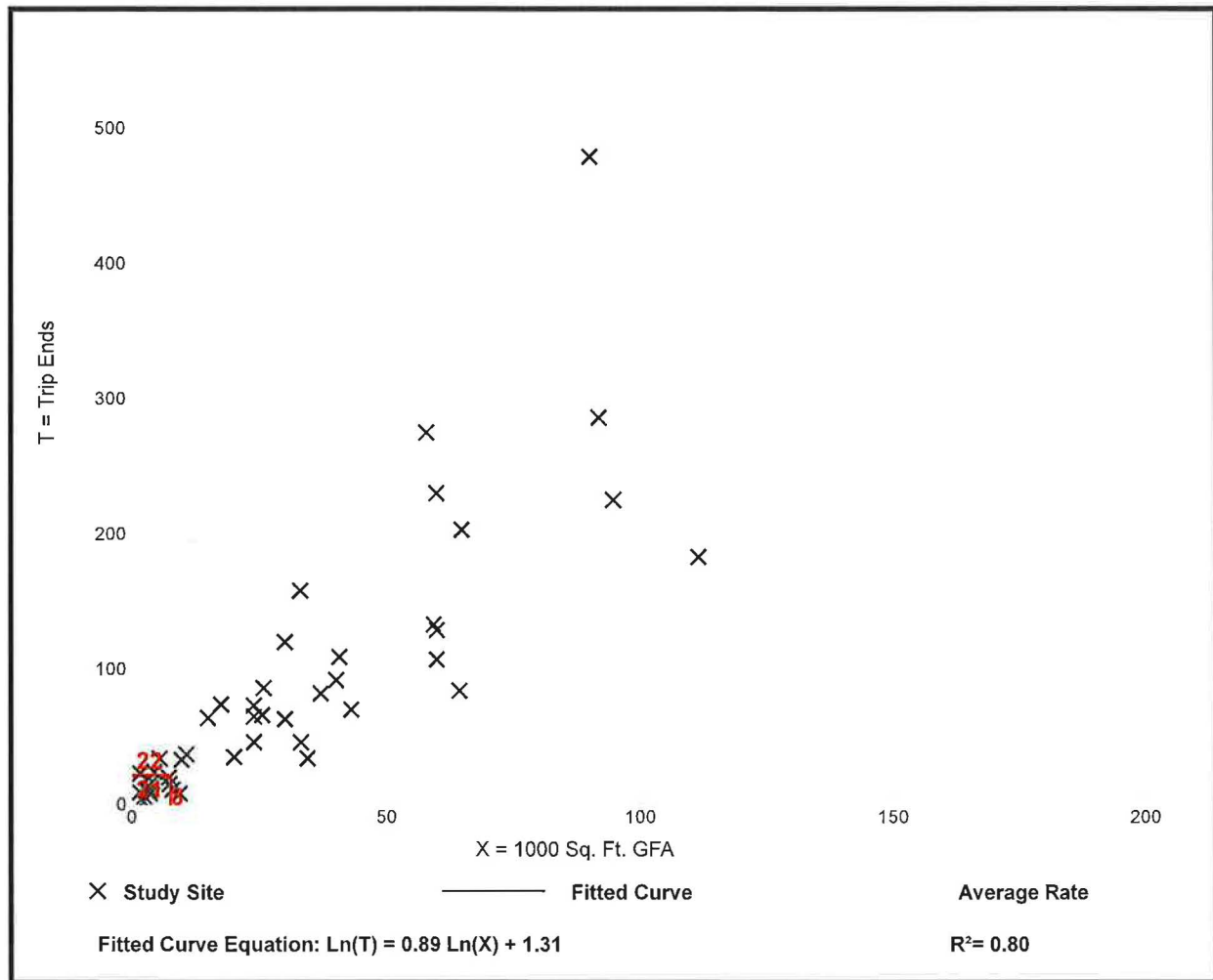

Trip Generation Manual, 10th Edition • Institute of Transportation Engineers

Medical-Dental Office Building (720)

Vehicle Trip Ends vs: 1000 Sq. Ft. GFA
On a: Weekday,
Peak Hour of Adjacent Street Traffic,
One Hour Between 4 and 6 p.m.
Setting/Location: General Urban/Suburban
 Number of Studies: 65
 Avg. 1000 Sq. Ft. GFA: 28
 Directional Distribution: 28% entering, 72% exiting

Vehicle Trip Generation per 1000 Sq. Ft. GFA

Average Rate	Range of Rates	Standard Deviation
3.46	0.25 - 8.86	1.58

Data Plot and Equation

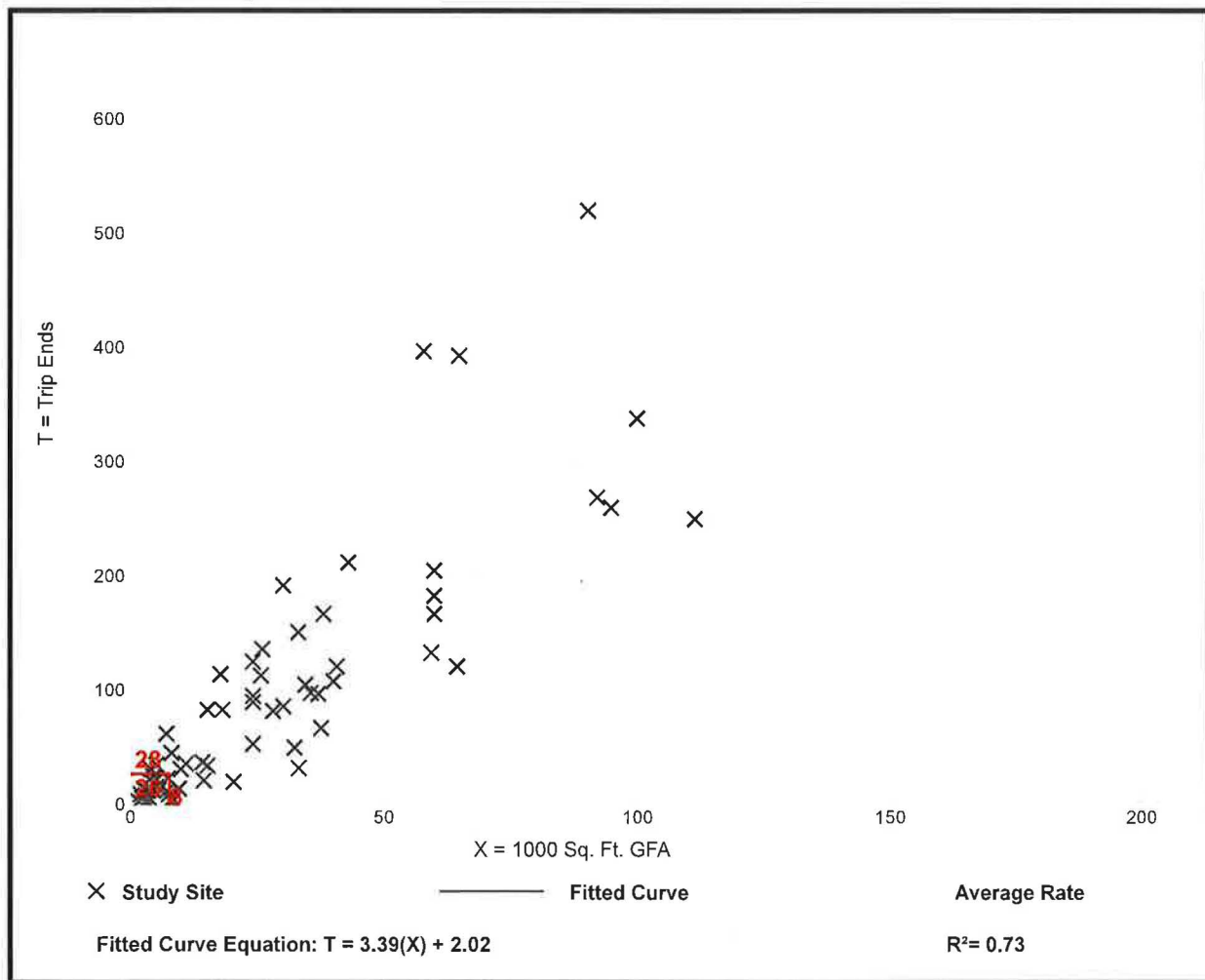

Trip Generation Manual, 10th Edition • Institute of Transportation Engineers

Fast-Food Restaurant with Drive-Through Window (934)

Vehicle Trip Ends vs: 1000 Sq. Ft. GFA
On a: Weekday

Setting/Location: General Urban/Suburban
Number of Studies: 67
Avg. 1000 Sq. Ft. GFA: 3
Directional Distribution: 50% entering, 50% exiting

Vehicle Trip Generation per 1000 Sq. Ft. GFA

Average Rate	Range of Rates	Standard Deviation
470.95	98.89 - 1137.66	244.44

Data Plot and Equation

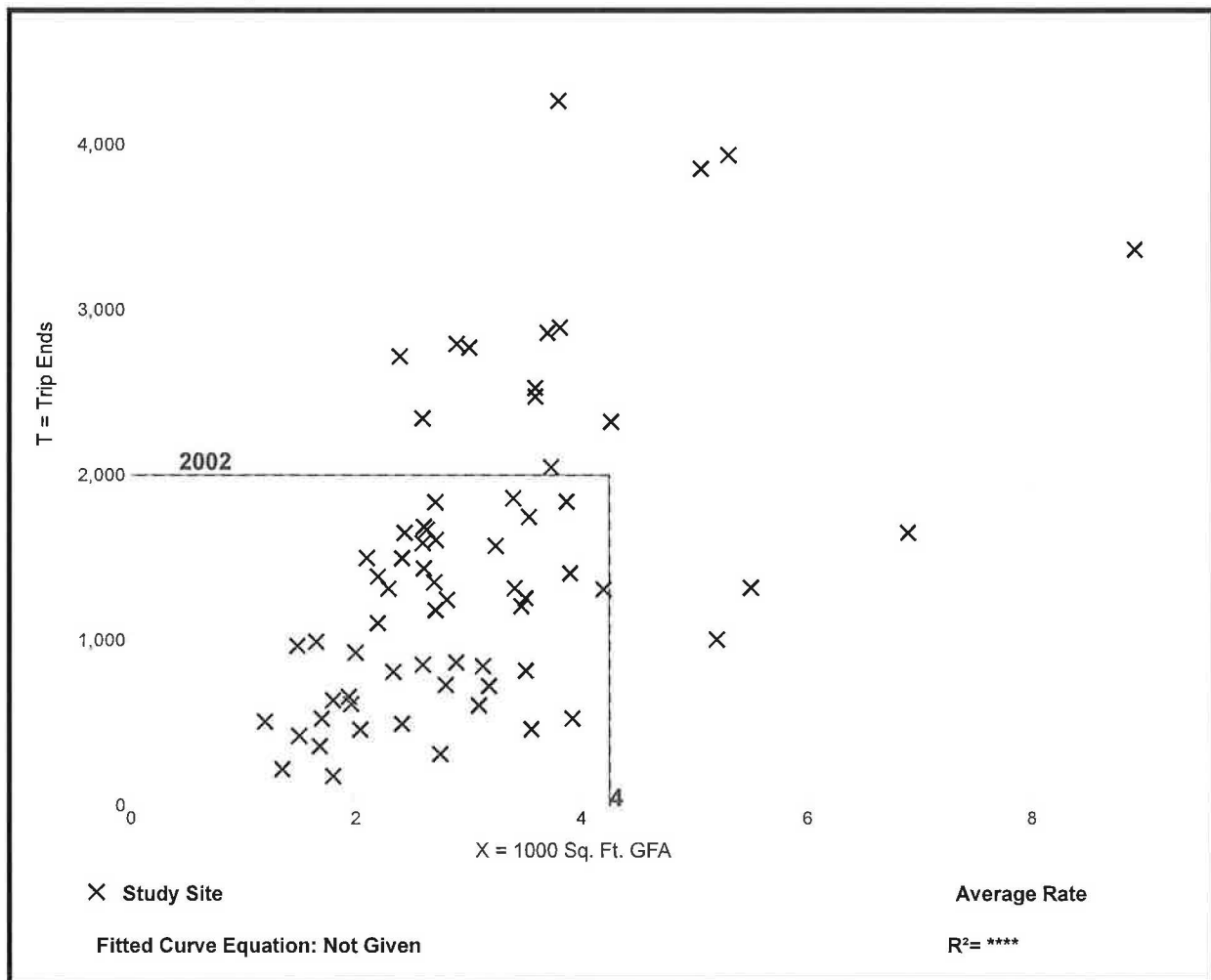

Trip Generation Manual, 10th Edition • Institute of Transportation Engineers

Fast-Food Restaurant with Drive-Through Window (934)

Vehicle Trip Ends vs: **1000 Sq. Ft. GFA**
 On a: **Weekday,**
Peak Hour of Adjacent Street Traffic,
One Hour Between 7 and 9 a.m.
Setting/Location: General Urban/Suburban
 Number of Studies: 111
 Avg. 1000 Sq. Ft. GFA: 4
 Directional Distribution: 51% entering, 49% exiting

Vehicle Trip Generation per 1000 Sq. Ft. GFA

Average Rate	Range of Rates	Standard Deviation
40.19	0.38 - 164.25	28.78

Data Plot and Equation

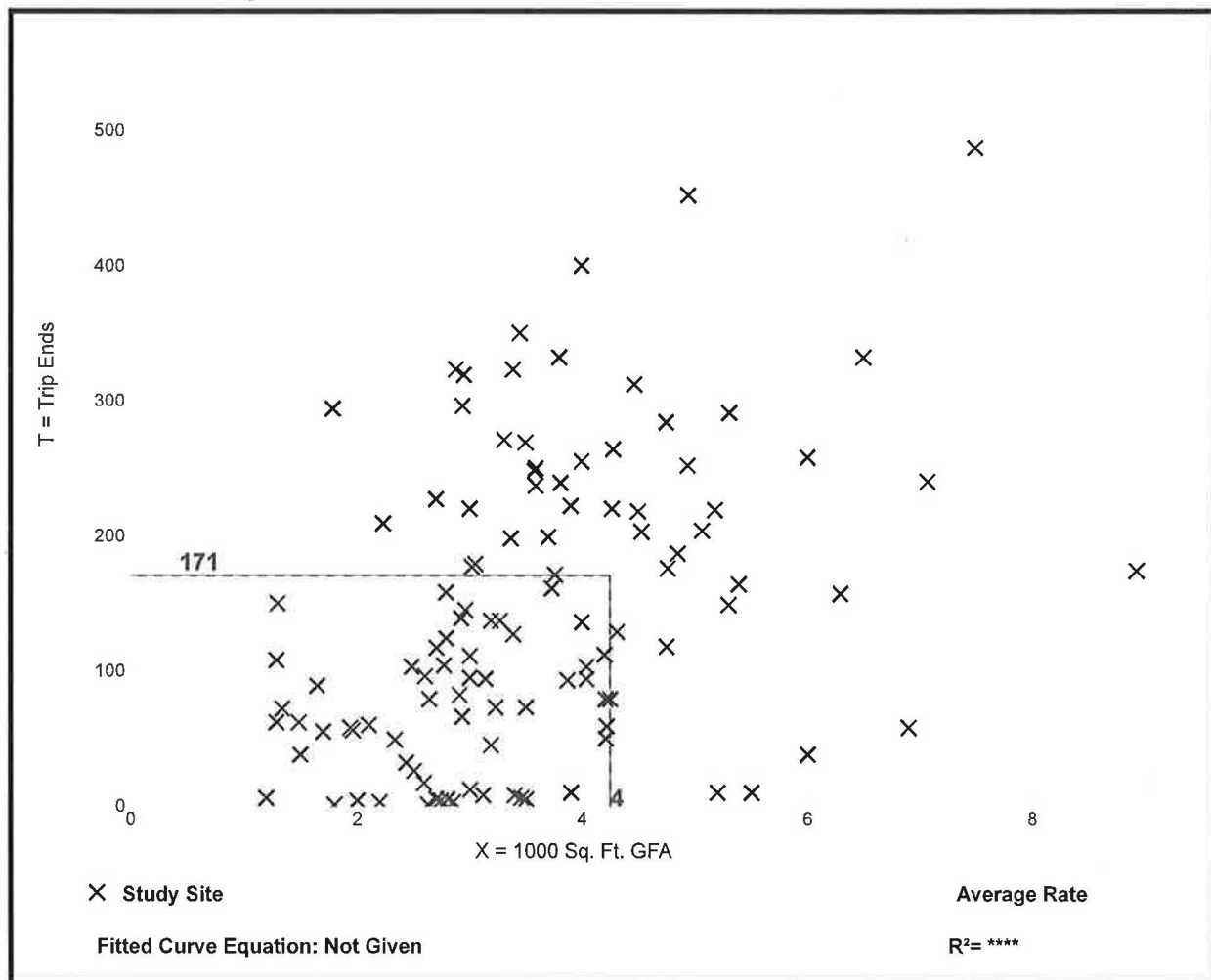

Trip Generation Manual, 10th Edition • Institute of Transportation Engineers

Fast-Food Restaurant with Drive-Through Window (934)

Vehicle Trip Ends vs: 1000 Sq. Ft. GFA
On a: Weekday,
Peak Hour of Adjacent Street Traffic,
One Hour Between 4 and 6 p.m.
Setting/Location: General Urban/Suburban
 Number of Studies: 185
 Avg. 1000 Sq. Ft. GFA: 3
 Directional Distribution: 52% entering, 48% exiting

Vehicle Trip Generation per 1000 Sq. Ft. GFA

Average Rate	Range of Rates	Standard Deviation
32.67	8.17 - 117.22	17.87

Data Plot and Equation

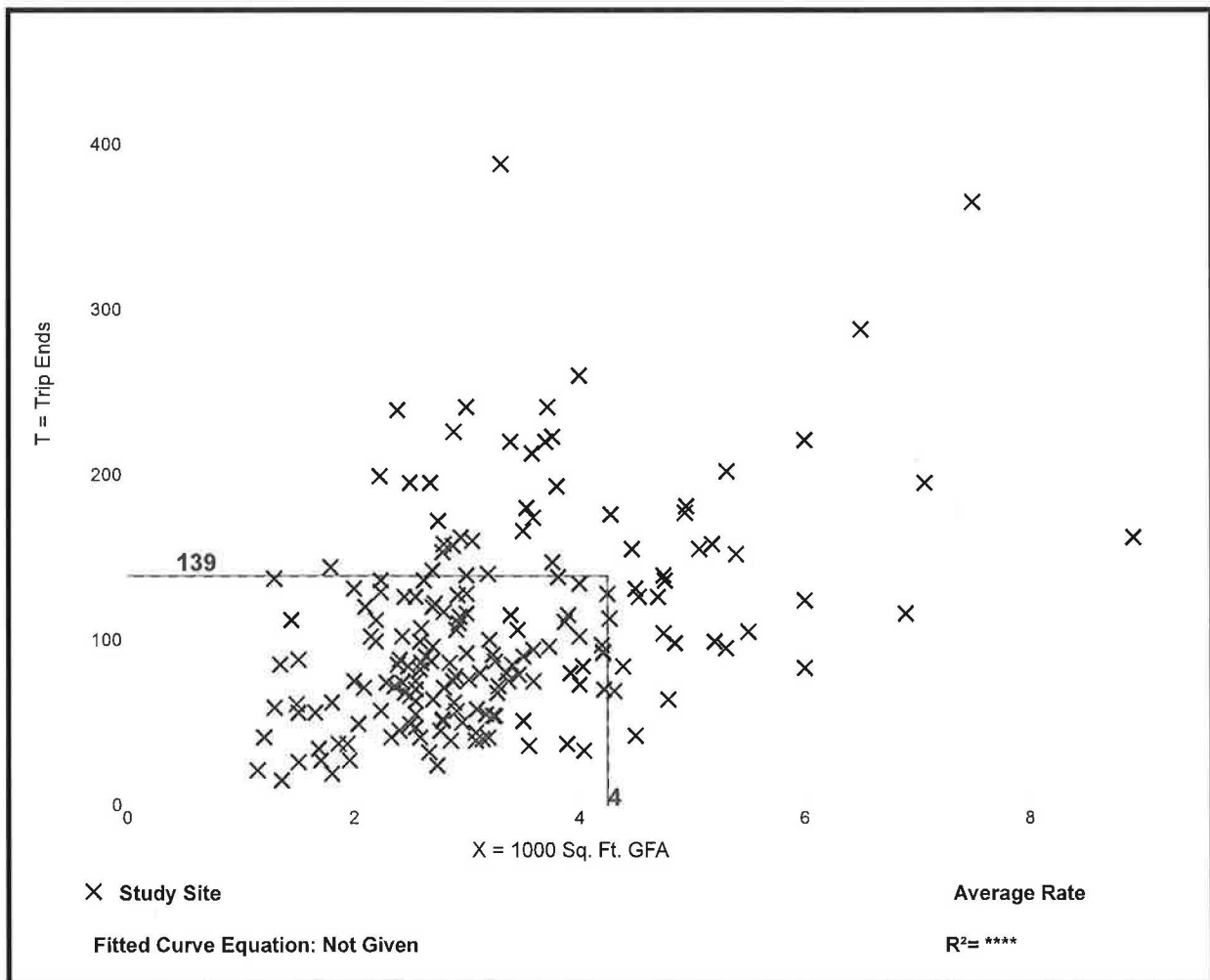

Trip Generation Manual, 10th Edition • Institute of Transportation Engineers

Automated Car Wash (948)

Vehicle Trip Ends vs: 1000 Sq. Ft. GFA
On a: Weekday,
Peak Hour of Adjacent Street Traffic,
One Hour Between 4 and 6 p.m.
Setting/Location: General Urban/Suburban
 Number of Studies: 1
 Avg. 1000 Sq. Ft. GFA: 2
 Directional Distribution: 50% entering, 50% exiting

Vehicle Trip Generation per 1000 Sq. Ft. GFA

Average Rate	Range of Rates	Standard Deviation
14.20	14.20 - 14.20	*

Data Plot and Equation

Caution – Small Sample Size

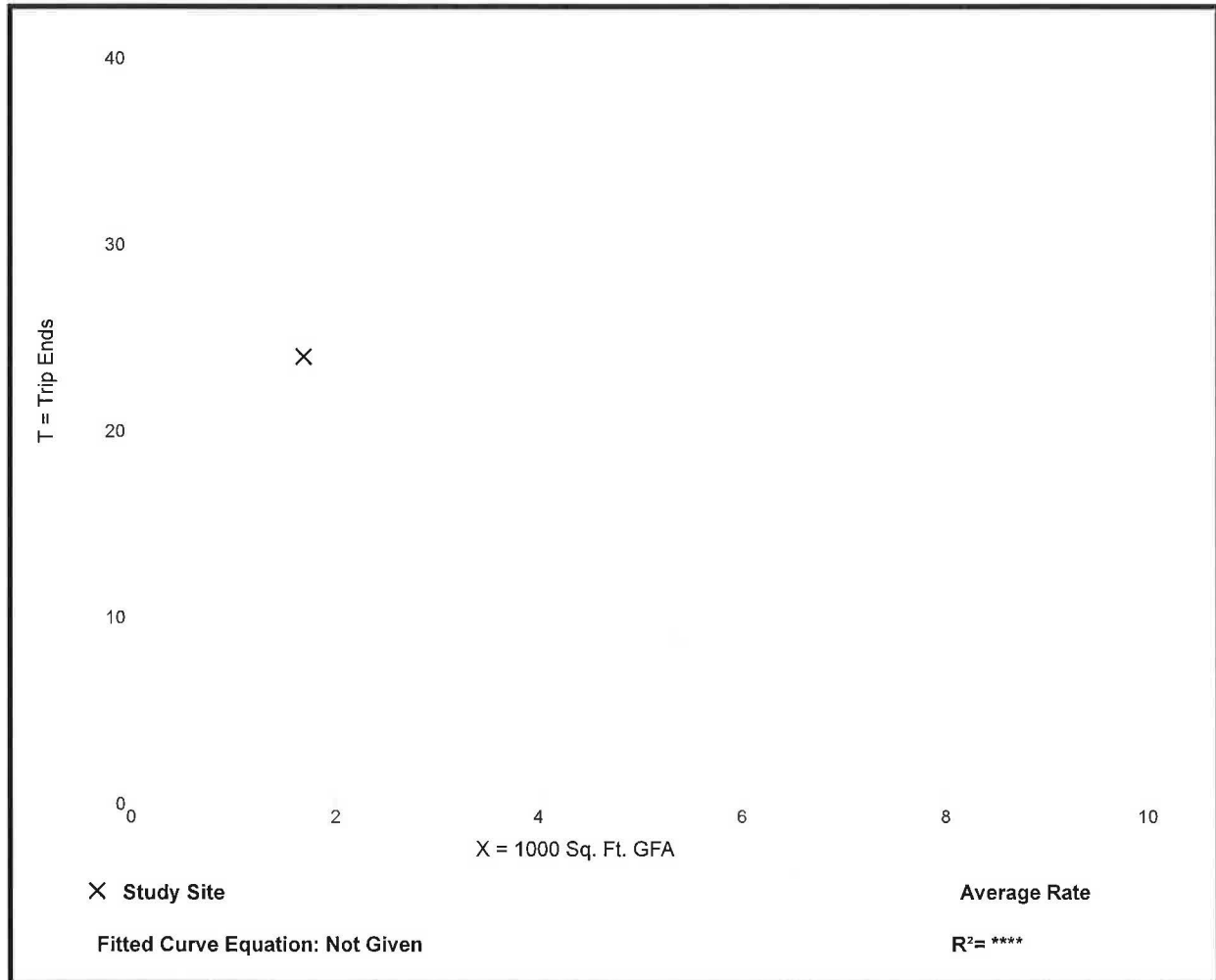

Trip Generation Manual, 10th Edition • Institute of Transportation Engineers

SITE PLAN

ALTA/NSPS LAND TITLE SURVEY



ATWELL
SURVEYING & CONSULTING INC.
2444 S. OREGON ST. #100
TOWNSHIP 1 NORTH, RANGE 8 EAST
OKLAHOMA COUNTY, OKLAHOMA 73167
PHONE: (405) 944-1234
FAX: (405) 944-1235
WWW.ATWELLSURVEYING.COM

CITY OF NOKIA
TOWNSHIP 1 NORTH, RANGE 8 EAST
SECTION 35
OKLAHOMA COUNTY, OKLAHOMA

LOCATED IN
WASHME PROPERTIES, LLC
ALTA/NSPS LAND TITLE SURVEY
DATE: 7/6/2018

DATE: 7/6/2018	SHEET NO. 2 OF 2
SCALE: AS SHOWN	DATE: _____
BY: [Signature]	DATE: _____
CHECKED BY: [Signature]	DATE: _____
PROJECT: ALTA/NSPS LAND TITLE SURVEY PARCEL: SECTION 35, TOWNSHIP 1 NORTH, RANGE 8 EAST, OKLAHOMA COUNTY, OKLAHOMA DRAWN BY: [Name] CHECKED BY: [Name] DATE: 7/6/2018	

Tree Tag #	Noting	Existing	Common Name	Botanical Name	Date Code	Diameter (in.)	Tree Health Condition	Classification*	Comments
2919	346024	13184234	Eastern Cottonwood	Populus deltoides	PODE	9.0	Good	Preserved	
2920	346024	13184234	Eastern Cottonwood	Populus deltoides	PODE	11.0	Excellent	Preserved	
2921	346024	13184234	Eastern Cottonwood	Populus deltoides	PODE	9.0	Excellent	Preserved	
2922	346024	13184234	Eastern Cottonwood	Populus deltoides	PODE	9.0	Good	Preserved	
2923	346024	13184234	Eastern Cottonwood	Populus deltoides	PODE	9.5	Good	Preserved	
2924	346024	13184234	Eastern Cottonwood	Populus deltoides	PODE	9.5	Good	Preserved	
2925	346024	13184234	Eastern Cottonwood	Populus deltoides	PODE	11.0	Good	Preserved	
2926	346024	13184234	Eastern Cottonwood	Populus deltoides	PODE	11.0	Good	Preserved	
2927	346024	13184234	Eastern Cottonwood	Populus deltoides	PODE	11.5	Good	Preserved	
2928	346024	13184234	Eastern Cottonwood	Populus deltoides	PODE	11.5	Excellent	Preserved	
2929	346024	13184234	Eastern Cottonwood	Populus deltoides	PODE	9.5	Good	Preserved	
2930	346024	13184234	Black Pine	Pinus strobus	PIBL	8.5	Good	Preserved	
2931	346024	13184234	Black Pine	Pinus strobus	PIBL	13.0	Good	Preserved	

*Classification based on Sec. 37-8 (Replacement of replacement of trees) of the City of Nokian Code of Ordinances. The City of Nokian requires all trees 6.0" DBH or larger which are recognized woodland areas which are subject to Section 37-4 (Applicability). - Preserved: Pursuant to Sec. 37-8.5 (Historic and specimen trees), a person may remove a specimen tree as a historic specimen tree based upon a written determination by the City of Nokian. Hyperlink to the City of Nokian's Ordinance Sec. 37-8.5 (Preserving and specimen trees). Note that one tree per quarter section must meet the minimum size qualifications as shown in the Specimen Tree Admission table on Sec. 37-8.5 (Preserving and specimen trees).

SURVEYOR'S CERTIFICATE
TO: FIRST AMERICAN TITLE INSURANCE COMPANY

THIS IS TO CERTIFY THAT THIS MAP OR PLAN AND THE SURVEY ON WHICH IT IS BASED WERE MADE IN ACCORDANCE WITH THE REQUIREMENTS OF TITLE INSURANCE ACTS AND NSPS AND CONTAINS NO TYPICAL TABLE. I, THE SURVEYOR, AM A LICENSED SURVEYOR IN THE STATE OF OKLAHOMA AND AM NOT PROVIDING ANY GUARANTEE OF TITLE.

FIELD WORK WAS COMPLETED ON JANUARY 23, 2018

JOHANN L. DUBROW, Surveyor No. 58880
 MISSOURI SOUTHERN SURVEYING & CONSULTING, INC.
 5047 JEFFERSON AVENUE, SUITE 100
 SOUTHFIELD, MICHIGAN 48078
 248.443.2500

SCHEDULE BI EXCEPTIONS (PER COMMENT FOR TITLE INSURANCE ISSUED BY FIRST AMERICAN TITLE INSURANCE COMPANY, FILE NO. NS-58816-MCH, COMMENT DATE: JANUARY 8, 2018)

6. The terms and provisions contained in the instrument entitled "Schedule B" in compliance with the provisions of the Title Insurance Act of Oklahoma, as amended, shall be deemed to apply to the land described herein. The instrument is subject to the provisions of the Title Insurance Act of Oklahoma, as amended, and the provisions of the Title Insurance Act of Oklahoma, as amended, shall be deemed to apply to the land described herein.

SCHEDULE A DESCRIPTION (PER COMMENT FOR TITLE INSURANCE ISSUED BY FIRST AMERICAN TITLE INSURANCE COMPANY, FILE NO. NS-58816-MCH, COMMENT DATE: JANUARY 8, 2018)

The land referred to in this commitment, situated in the County of Cleveland, City of Nokian, State of Oklahoma, is described as follows:

Parcel 1, of the Northwest 1/4 of Section 35, Township 1 North, Range 8 East, Oklahoma County, Oklahoma, which contains 40 acres, more or less, and is bounded on the north by the Northwest 1/4 of Section 34, Township 1 North, Range 8 East, Oklahoma County, Oklahoma, which contains 40 acres, more or less, on the east by the Northwest 1/4 of Section 36, Township 1 North, Range 8 East, Oklahoma County, Oklahoma, which contains 40 acres, more or less, on the south by the Northwest 1/4 of Section 35, Township 1 North, Range 8 East, Oklahoma County, Oklahoma, which contains 40 acres, more or less, and on the west by the Northwest 1/4 of Section 35, Township 1 North, Range 8 East, Oklahoma County, Oklahoma, which contains 40 acres, more or less.

Tree Tag #	Noting	Existing	Common Name	Botanical Name	Date Code	Diameter (in.)	Tree Health Condition	Classification*	Comments
2932	346024	13184234	American Elm	Ulmus americana	UAMA	9.0	Fair	Preserved	Crossed crown
2933	346024	13184234	American Elm	Ulmus americana	UAMA	16.5	Good	Preserved	
2934	346024	13184234	American Elm	Ulmus americana	UAMA	16.5	Good	Preserved	
2935	346024	13184234	American Elm	Ulmus americana	UAMA	14.5	Fair	Preserved	
2936	346024	13184234	American Elm	Ulmus americana	UAMA	14.5	Good	Preserved	
2937	346024	13184234	American Elm	Ulmus americana	UAMA	8.0	Good	Preserved	
2938	346024	13184234	American Elm	Ulmus americana	UAMA	9.0	Good	Preserved	
2939	346024	13184234	American Elm	Ulmus americana	UAMA	11.0	Good	Preserved	
2940	346024	13184234	American Elm	Ulmus americana	UAMA	13.0	Good	Preserved	
2941	346024	13184234	American Elm	Ulmus americana	UAMA	13.0	Good	Preserved	
2942	346024	13184234	American Elm	Ulmus americana	UAMA	8.5	Fair	Preserved	
2943	346024	13184234	American Elm	Ulmus americana	UAMA	8.5	Good	Preserved	
2944	346024	13184234	American Elm	Ulmus americana	UAMA	15.5	Good	Preserved	
2945	346024	13184234	American Elm	Ulmus americana	UAMA	8.0	Good	Preserved	
2946	346024	13184234	American Elm	Ulmus americana	UAMA	9.5	Fair	Preserved	
2947	346024	13184234	American Elm	Ulmus americana	UAMA	8.5	Fair	Preserved	
2948	346024	13184234	American Elm	Ulmus americana	UAMA	8.0	Good	Preserved	
2949	346024	13184234	American Elm	Ulmus americana	UAMA	8.0	Good	Preserved	
2950	346024	13184234	American Elm	Ulmus americana	UAMA	8.0	Good	Preserved	
2951	346024	13184234	American Elm	Ulmus americana	UAMA	8.0	Good	Preserved	
2952	346024	13184234	American Elm	Ulmus americana	UAMA	8.0	Good	Preserved	
2953	346024	13184234	American Elm	Ulmus americana	UAMA	8.0	Good	Preserved	
2954	346024	13184234	American Elm	Ulmus americana	UAMA	8.0	Good	Preserved	
2955	346024	13184234	American Elm	Ulmus americana	UAMA	8.5	Good	Preserved	
2956	346024	13184234	American Elm	Ulmus americana	UAMA	8.5	Good	Preserved	
2957	346024	13184234	American Elm	Ulmus americana	UAMA	8.5	Good	Preserved	
2958	346024	13184234	American Elm	Ulmus americana	UAMA	8.5	Good	Preserved	
2959	346024	13184234	American Elm	Ulmus americana	UAMA	8.5	Good	Preserved	
2960	346024	13184234	American Elm	Ulmus americana	UAMA	8.5	Good	Preserved	
2961	346024	13184234	American Elm	Ulmus americana	UAMA	8.5	Good	Preserved	
2962	346024	13184234	American Elm	Ulmus americana	UAMA	8.5	Good	Preserved	
2963	346024	13184234	American Elm	Ulmus americana	UAMA	8.5	Good	Preserved	
2964	346024	13184234	American Elm	Ulmus americana	UAMA	8.5	Good	Preserved	
2965	346024	13184234	American Elm	Ulmus americana	UAMA	8.5	Good	Preserved	
2966	346024	13184234	American Elm	Ulmus americana	UAMA	8.5	Good	Preserved	
2967	346024	13184234	American Elm	Ulmus americana	UAMA	8.5	Good	Preserved	
2968	346024	13184234	American Elm	Ulmus americana	UAMA	8.5	Good	Preserved	
2969	346024	13184234	American Elm	Ulmus americana	UAMA	8.5	Good	Preserved	

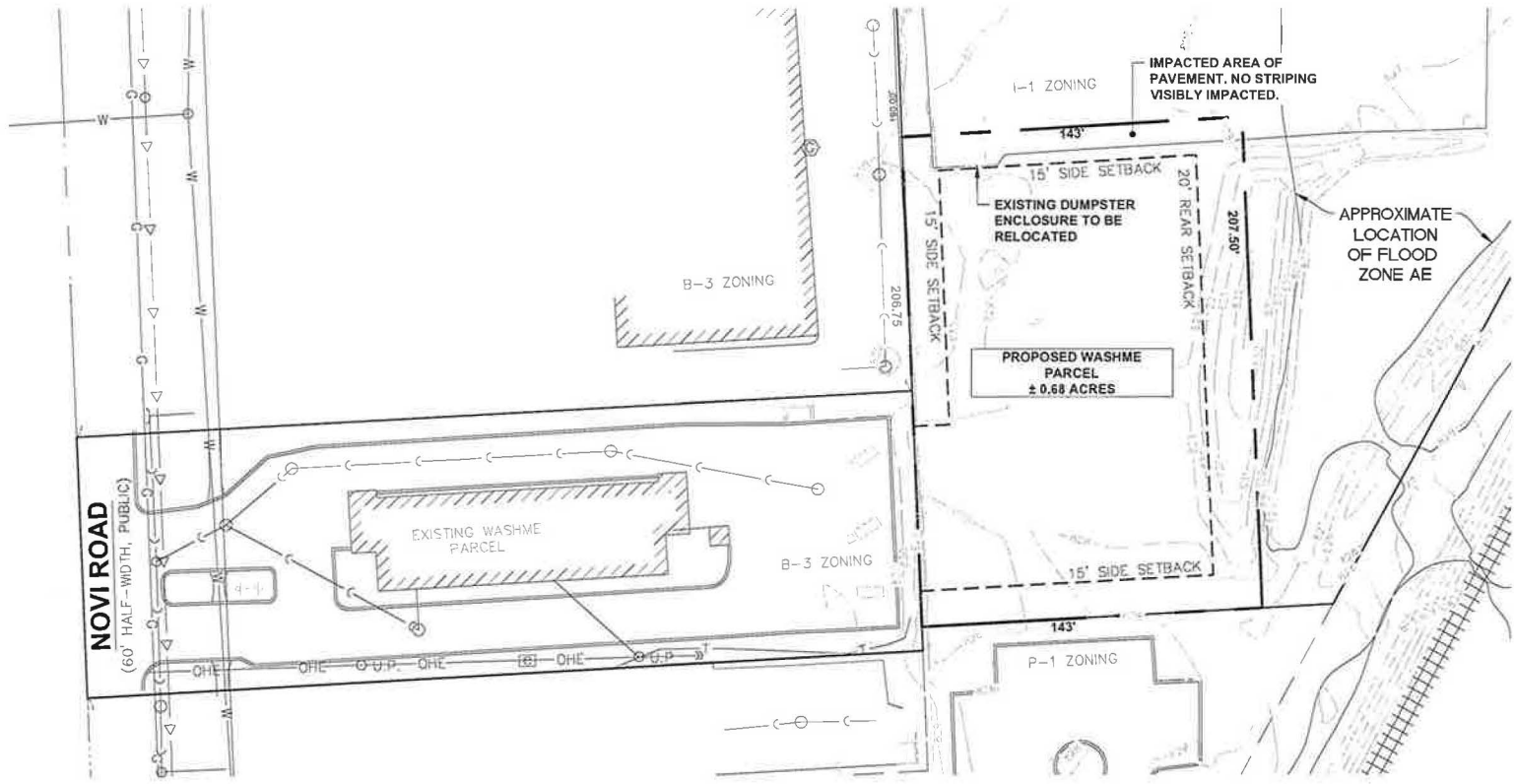

NOTES

1. PROPOSED PARCEL APPROXIMATELY 1-2' BELOW EXISTING PARCEL. ANTICIPATE SIGNIFICANT EARTHWORK ACTIVITY.
2. DETENTION REQUIRED, BASED ON PRELIMINARY REVIEW OF EXISTING STORM SEWER INVERT ELEVATIONS, THE AVAILABLE OUTLET DEPTH IS VERY SHALLOW, FURTHER DESIGN FEASIBILITY FOR DETENTION WILL BE REQUIRED.
3. PROPOSED PARCEL ZONED I-1, WILL NEED TO BE REZONED B-3.
4. SETBACKS BASED ON B-3 ZONING.
5. FLOODPLAIN LIMITS SHOWN ARE APPROXIMATE AND WILL NEED TO BE CONFIRMED.

SITE DATA

PID	AREA	ZONING
22-35-101-036 (PARENT PARCEL)	0.68 AC.	I-1
22-35-101-006 (EXISTING PARCEL)	0.88 AC.	B-3
	±1.56 AC.	



WASHME CONCEPT
CITY OF NOVI, MI
CONCEPT 1

DRAWN BY: JC
DATE: 2/8/17
SCALE: 1"=50'

POTENTIAL USES SITE PLANS

NOVI ROAD
(60' HALF-WIDTH, PUBLIC)

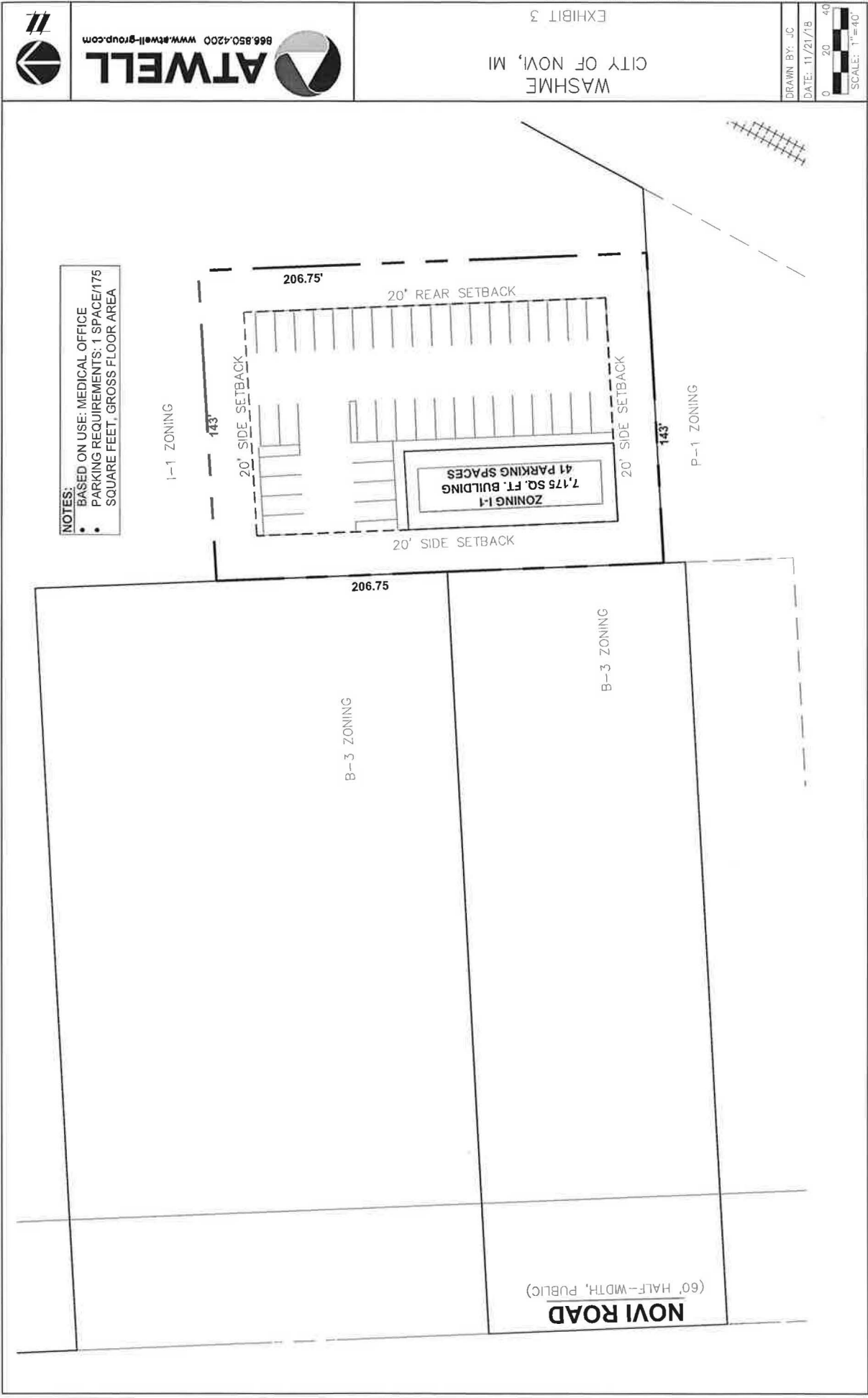

NOTES:
• BASED ON USE: MEDICAL OFFICE
• PARKING REQUIREMENTS: 1 SPACE/175 SQUARE FEET, GROSS FLOOR AREA



ATWELL
866.850.4200 www.atwell-group.com

WASHME
CITY OF NOVI, MI
EXHIBIT 3

DRAWN BY: JC
DATE: 11/21/18
SCALE: 1"=40'

WASHME
CITY OF NOVI, MI
EXHIBIT 1



ATWELL
866.850.4200 www.atwell-group.com

DRAWN BY: JC
DATE: 11/21/18
0 20 40
SCALE: 1"=40'

NOTES:
• BASED ON USE: MEDICAL OFFICE
• PARKING REQUIREMENTS: 1 SPACE/175 SQUARE FEET, GROSS FLOOR AREA

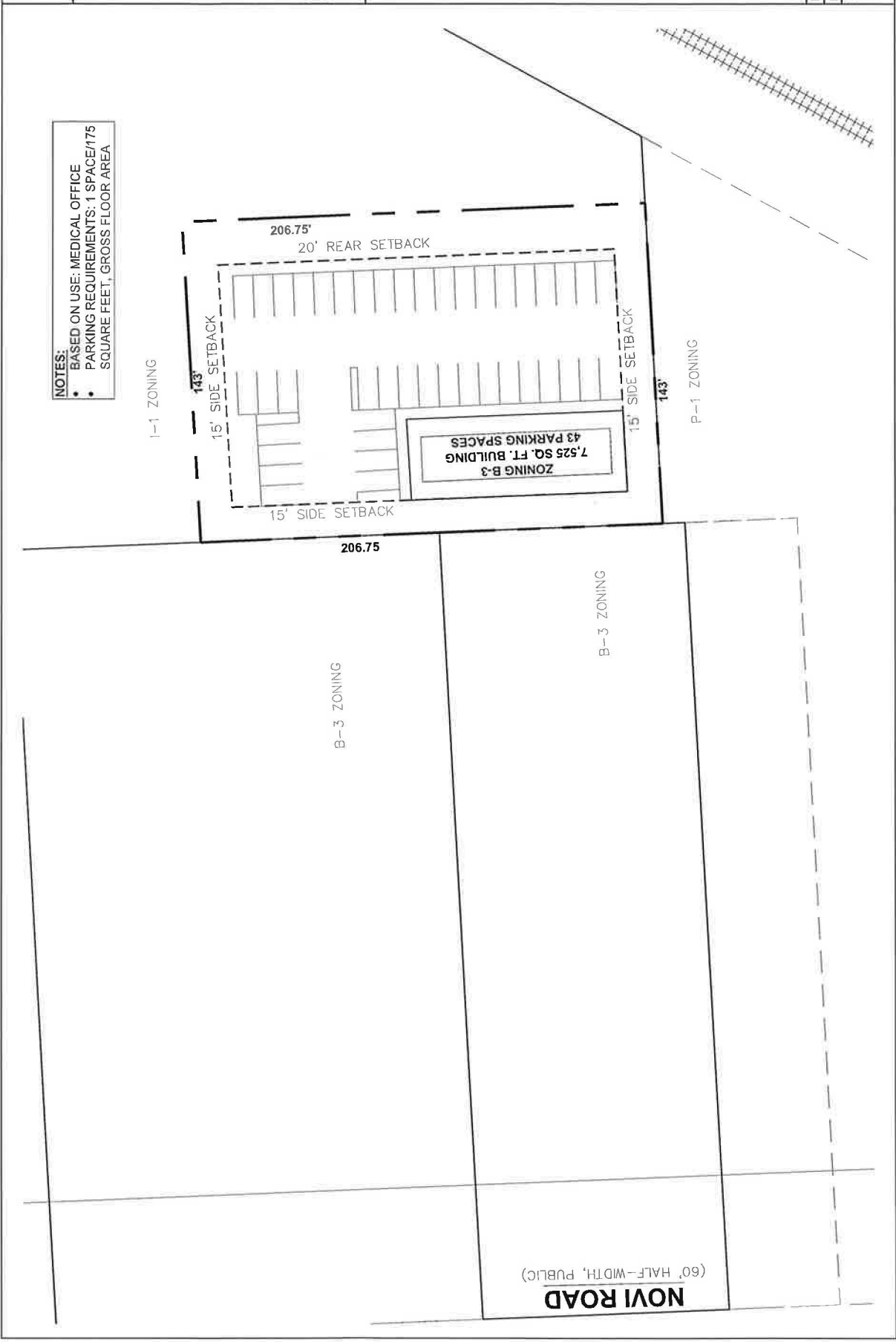

NOVI ROAD
(60' HALF-WIDTH, PUBLIC)

NOVI ROAD
(60' HALF-WIDTH, PUBLIC)

ZONING B-3
4,250 SQ. FT. BUILDING
43 PARKING SPACES

B-3 ZONING

B-3 ZONING

- NOTES:**
- BASED ON USE: FAST FOOD RESTAURANT
 - PARKING REQUIREMENTS: 1 SPACE/2 EMPLOYEES + 1 SPACE/2 CUSTOMERS (ASSUMING 6 EMPLOYEES/80 PERSON CAPACITY)

I-1 ZONING

143'
15' SIDE SETBACK

15' SIDE SETBACK

206.75'
20' REAR SETBACK

15' SIDE SETBACK

143'

P-1 ZONING

DRAWN BY: JC

DATE: 11/21/18

0' 20' 40'
SCALE: 1"=40'

WASHME
CITY OF NOVI, MI

EXHIBIT 2

CAD FILE: K:\17003282\DWG\LIBRARY\17003282 WS002 TRAFFIC STUDY EXHIBIT

